

memmert

Operating manual



HPPeco

Constant Climate Chamber HPPeco

Table of Contents

1. About this Manual	5
2. Safety	7
2.1 Terms and Symbols Used	7
2.1.1 Terms Used.....	7
2.1.2 Symbols Used	7
2.2 Product Safety and Dangers.....	8
2.3 Requirements to be met by Operating Personnel.....	9
2.4 Responsibility of the Owner	9
2.5 Product Use	9
2.5.1 Intended Use.....	9
2.5.2 Improper Use	9
2.6 Changes and Alterations.....	9
2.7 Behaviour in case of Malfunctions and Irregularities	10
2.8 Switching off the Unit in an Emergency.....	10
3. Construction and Description	11
3.1 Design.....	11
3.2 Description of Function	12
3.3 Materials	14
3.4 Electrical Equipment.....	14
3.5 Connections and Interfaces	14
3.5.1 Electrical Connection.....	14
3.5.2 Communication Interfaces.....	14
3.6 Nameplate.....	15
3.7 Technical Data	16
3.8 Applied Directives and Standards.....	18
3.8.1 Declaration of Conformity.....	18
3.8.2 Material Compliance.....	18
3.9 Ambient Conditions.....	19
3.10 Scope of Delivery	19
4. Delivery, Transport and Setting Up	20
4.1 Safety.....	20
4.2 Delivery	20
4.3 Transport.....	21
4.4 Unpacking.....	21
4.5 Storage after Delivery	21
4.6 Setting Up.....	21
4.6.1 Preconditions.....	21
4.6.2 Installation Options	22
4.6.3 Levelling the Appliance.....	23

4.6.4	Anti-tilt bracket	24
4.6.5	Adjusting the Doors	24
5.	Putting into Operation	26
5.1	Putting into Operation for the First Time	26
5.2	Connecting the Unit to the Power Supply	26
5.3	Water specifications	26
5.4	Connecting and Filling the Water Tank	27
5.5	Hook in Drip Pan	27
5.6	Switching on Unit	27
6.	Operation and Control	29
6.1	Operating Personnel	29
6.2	Opening the Door	29
6.3	Loading the Appliance	30
6.4	Operating the Appliance	31
6.4.1	ControlCOCKPIT	31
6.4.2	Basic Operation	32
6.5	Operating Modes	32
6.5.1	Manual Mode	33
6.5.2	Digital Backwards Counter	34
6.5.3	Programme Mode	35
6.6	Monitoring Function	37
6.6.1	Temperature Monitoring	37
6.6.2	Electronic Temperature Monitoring (TWW)	38
6.6.3	Automatic Temperature Monitor (ASF)	38
6.6.4	Adjusting the Temperature Monitoring	38
6.6.5	Humidity Monitoring	40
6.7	Graph	41
6.7.1	Temperature Curve	41
6.7.2	Humidity Profile	41
6.8	Ending Operation	42
7.	Malfunctions, Warning and Error Messages	43
7.1	Warning Message of the Monitoring Function	43
7.1.1	Temperature Monitoring	43
7.1.2	Humidity Monitoring	44
7.2	Malfunctions, Operating Problems and Unit Errors	44
7.2.1	Power Failure	45
8.	Menu Mode	46
8.1	Overview	46
8.2	Basic Operation in Menu Mode Using the Example of Language Selection	46
8.3	Setup	47

8.3.1	Overview	47
8.3.2	IP Address and Subnet Mask	48
8.3.3	Unit	49
8.3.4	Timer Mode	49
8.3.5	Shelf Type (Grid or metal plate).....	49
8.3.6	Balance	50
8.3.7	Dehumidification Interval	50
8.3.8	Remote Control	51
8.3.9	Gateway.....	51
8.4	Date and Time.....	51
8.5	Calibrate.....	52
8.5.1	Temperature Calibration	52
8.5.2	Humidity Calibration	54
8.6	Programme.....	56
8.7	Acoustic Signals	57
8.8	Log.....	58
8.9	USER ID	58
8.9.1	Description	58
8.9.2	USER ID Activation and Deactivation	59
9.	Maintenance and Servicing	60
9.1	Cleaning	60
9.2	Decontamination.....	61
9.3	Regular Maintenance.....	61
9.4	Repairs and Service.....	61
10.	Storage, Transport and Disposal	62
10.1	Storage and Transport.....	62
10.2	Disposal	62

1. About this Manual

Purpose and target audience

This manual describes the design, function, transport, operation and maintenance of the product series Constant climate chambers HPPeco. It is intended for use by trained personnel employed by the owner who are tasked with operating and/or maintaining the unit.

If you have been tasked with working on the unit, read this manual carefully before starting work. Familiarise yourself with the safety instructions. Only perform work that is described in this manual. If there is anything you do not understand, or if any information is lacking, ask your line manager or contact the manufacturer. Do not take any course of action on your own initiative.

Versions

The appliances are available in different equipment versions and sizes. If certain features or functions are only available in certain equipment versions, this is indicated at the relevant points in this manual.

The functions described in this manual relate to the most recent firmware version.

Due to the different equipment versions and sizes, the illustrations in this manual may be slightly different to your product. However, the product is identical in terms of its operation and function.

Further applicable documents

In addition to this manual, please observe the following documents:

- Service manual:
To carry out service and repair work you will require the separate service manual. Manuals can be requested from Memmert International After Sales or downloaded from **www.memmert.com**.
- AtmoCONTROL software manual
When operating the unit with the MEMMERT AtmoCONTROL PC software you will require the separate manual. You can find the manual for the AtmoCONTROL software in the AtmoCONTROL menu bar under 'Help'

Retaining and passing on this manual

This operating manual belongs to the unit and must always be kept in a location where it can be easily found by those working with the unit. It is the responsibility of the owner to ensure that persons who work on the unit know where this operating manual is. We recommend always storing it in a safe place near the unit.

Ensure that the manual is not damaged by heat or humidity. If the unit is sold or transported and re-installed at another location, this operating manual must be handed over with the unit. The current version of this operating manual is also available in PDF format at **www.memmert.com**.

Address and Customer Service

Manufacturer's address

Memmert GmbH + Co. KG
Äußere Rittersbacher Straße 38 D-91126 Schwabach Germany
Tel. +49 9122 925-0
E-mail: sales@memmert.com
www.memmert.com

International After Sales

Memmert GmbH + Co. KG
Willi-Memmert-Straße 90-96 D-91186 Büchenbach Germany
Tel. +49 9171 9792 911
E-mail: service@memmert.com
www.memmert.com
If you have any queries, please always quote the product number on the nameplate.

Shipping address for repairs

Memmert GmbH + Co. KG
Willi-Memmert-Straße 90-96 D-91186 Büchenbach Germany
Please contact our customer service before sending appliances for repair or before making returns, otherwise, we have to refuse acceptance of the shipment.

2. Safety

2.1 Terms and Symbols Used

In this manual and on the unit itself, certain recurring terms and symbols are used to warn you of hazards or give you information that is important in order to prevent injury or damage. To avoid accidents and damage, observe and follow these instructions. These terms and symbols are explained below.

2.1.1 Terms Used

	Warns of a dangerous situation that will result directly in death or serious (irreversible) injury.
	Warns of a dangerous situation that could result in death or serious physical injury.
	Warns of a dangerous situation that could result in moderate or minor physical injury.
	Warns of damage to property.

2.1.2 Symbols Used

	Do not lift unit		Do not enter
	Do not tilt		Risk of explosion
	Gases / vapours		General warning sign
	Danger of electrocution		Tipping hazard
	Flammable substances		Hot surfaces
	Disconnect the mains plug		Observe information in separate manual
	Wear gloves		Wear safety shoes

2.2 Product Safety and Dangers

The units described in this manual are technically sophisticated, manufactured using high-quality materials and subject to many hours of testing in the factory. They reflect the state of the art and comply with recognised technical safety regulations. However, there are still risks involved, even when the units are used as intended. These are described below.

DANGER



Danger due to electric shock

Penetration of liquid into the unit can cause electric shocks and short circuits.

- Protect the unit from splashing water.
- Switch off the unit and disconnect the mains plug before carrying out any cleaning and maintenance work.
- The unit must not be wet cleaned and disinfected. Allow the unit to dry completely before putting it back into operation.

DANGER



Danger of suffocation inside the appliance

If the appliances is a certain size, you can get accidentally locked in, which is potentially life-threatening.

- Do not climb into the appliance.
- Do not carry out cleaning work in the chamber alone.

WARNING



Poisonous or explosive vapours and gases

When loading the unit with an unsuitable load, poisonous or explosive vapours or gases may be produced. This could cause the unit to explode, and persons could be severely injured or poisoned.

- The unit may only be loaded with materials and substances which cannot form any toxic or explosive vapours at the set temperature and which cannot explode, burst or ignite.

WARNING



Hot surfaces

Depending on the operating situation, the unit and the load may be hot. Contact with hot surfaces may have serious health consequences due to burns!

- Allow the unit to cool down.
- Wear heat-resistant protective gloves when carrying out work.
- Check the temperature of surfaces before touching them.

WARNING



Overheating of the appliance when door is open

Leaving the door open during operation can cause the appliance to overheat or pose a fire hazard.

- Do not leave the door open during operation.

WARNING



Fire hazard when removing heated chamber loads

When removing the heated chamber load from the appliance, it can fall and cause fire hazards.

- The appliance must not be placed on a surface made of flammable material.

2.3 Requirements to be met by Operating Personnel

The appliance may only be operated and maintained by persons who are of legal age and have been instructed accordingly. It is intended to be operated and maintained by trained personnel employed by the owner.

Repairs may only be performed by qualified electricians. The guidelines in the separate service manual must be observed.

2.4 Responsibility of the Owner

The owner of the unit

- is responsible for the flawless condition of the unit and for operating it in accordance with its intended use;
- is responsible for ensuring that persons who operate or service the unit are qualified to do this, have been instructed accordingly and are familiar with these operating instructions;
- must know the applicable guidelines, requirements and operational safety regulations, and train staff accordingly;
- is responsible for ensuring that unauthorised persons cannot access the unit;
- is responsible for ensuring that the maintenance plan is adhered to and that maintenance work is properly carried out;
- has to ensure that the unit and its surroundings are kept clean and tidy, for example through corresponding instructions and inspections;
- is responsible for ensuring that personal protective clothing is worn by operating personnel, e.g. work clothes, safety shoes and protective gloves.

2.5 Product Use

2.5.1 Intended Use

Constant climate chambers HPPeco must only be used for temperature and climate testing of materials and substances in the context of the procedures and specifications described in this manual.

2.5.2 Improper Use

Any other use is improper and may result in danger and damage.

The appliance is not explosion-proof (does not comply with the German occupational health and safety regulation VBG 24). Only materials and substances which cannot form any toxic or explosive vapours at the set temperature and which cannot explode, burst or ignite may be put in the appliance.

The appliance must not be used to dry, vaporise or brand materials whose procurement or constituents pose a risk of fire and/or explosion, especially if the solvents of these materials could form an explosive mixture when combined with air. If you are not sure whether a given material has these characteristics, you must not put it in the appliance. Potentially explosive gas-air mixtures must not be able to form in the working chamber or in the direct vicinity of the appliance.

2.6 Changes and Alterations

Unauthorised changes or alterations must not be made to the appliance. Parts that are not approved by the manufacturer must not be mounted or built in.

Unauthorised changes or alterations result in the CE declaration of conformity losing its validity, and the appliance must no longer be operated.

The manufacturer is not liable for any damage, danger or injuries that emanating from unauthorised changes or alterations, or from non-compliance with the provisions in this manual.

2.7 Behaviour in case of Malfunctions and Irregularities



The unit must only be used in a flawless condition. If you, as the operator, notice irregularities, malfunctions or damage, immediately turn off the unit and inform your line manager.



You can find information on troubleshooting in the chapter ▶7 Malfunctions, Warning and Error Messages.

See also

📖 Malfunctions, Warning and Error Messages [▶ 43]

2.8 Switching off the Unit in an Emergency

⚠️ WARNING



Hot surfaces

Depending on the operating situation, the unit and the load may be hot. Contact with hot surfaces may have serious health consequences due to burns!

- Allow the unit to cool down.
- Wear heat-resistant protective gloves when carrying out work.
- Check the temperature of surfaces before touching them.

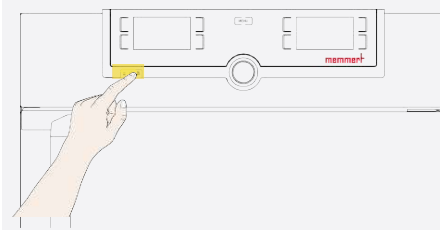

1. Press the main switch on the appliance.
 2. Unplug the mains plug from the power source.
- ⇒ This disconnects the appliance from the power supply at all poles.

3. Construction and Description

3.1 Design

Overview - HPP110eco



1 ControlCOCKPIT with capacitive function keys and LCD display	2 Main switch
3 Turn control with confirmation key	4 Peltier element
5 Inner glass door	6 Shelves
7 Peltier dehumidifier	8 Nameplate
9 Door handle	10 USB interface

Overview - HPP1400eco



1 ControlCOCKPIT with capacitive function keys and LCD display	2 Main switch
3 Turn control with confirmation key	4 Shelves
5 Heated full-sight glass door	6 Lockable castors with extendable feet
7 Nameplate	8 Door handle
9 USB interface	

3.2 Description of Function

Appliance size 110 to 1060

The appliances can heat the chamber up to +70 °C and cool it down to +5 °C. Low-noise, long-life energy-saving Peltier cooling and heating technology is used for this. In heating operation, some of the required energy is extracted from the surroundings (heat pump principle).

Additionally, the humidity in the chamber can be regulated between 10% rh and 90% rh. The humidity is increased by evaporating water from a tank then feeding it into the chamber and is reduced by condensation on a Peltier module.

Optionally, the appliance can be equipped with a light cartridge, making it possible to adjust the interior lighting in 1% increments.

Appliance size 1400 to 2200

The appliances can heat the chamber up to 70 °C and cool it down to +5 °C. Low-noise, long-life energy-saving Peltier cooling and heating technology is used for this. In heating operation, some of the required energy is extracted from the surroundings (heat pump principle).

Additionally, the humidity in the chamber can be regulated between 10% rh and 80% rh. The humidity is increased by evaporating water from a tank then feeding it into the chamber and is reduced by condensation on a Peltier module.

Functional description of climate diagram

The temperature-humidity diagram specifies the temperature and humidity range in which the constant climate chamber HPPeco can be operated continuously without condensation forming.

If the chamber is operated at the upper limit or outside the working range for long periods, puddles of water may form inside the chamber and water may force its way out of the door seal.

Climate points in the threshold range of the climate diagram can only be reached with the correct dehumidification interval. To find the optimum time interval, see "Dehumidification interval".

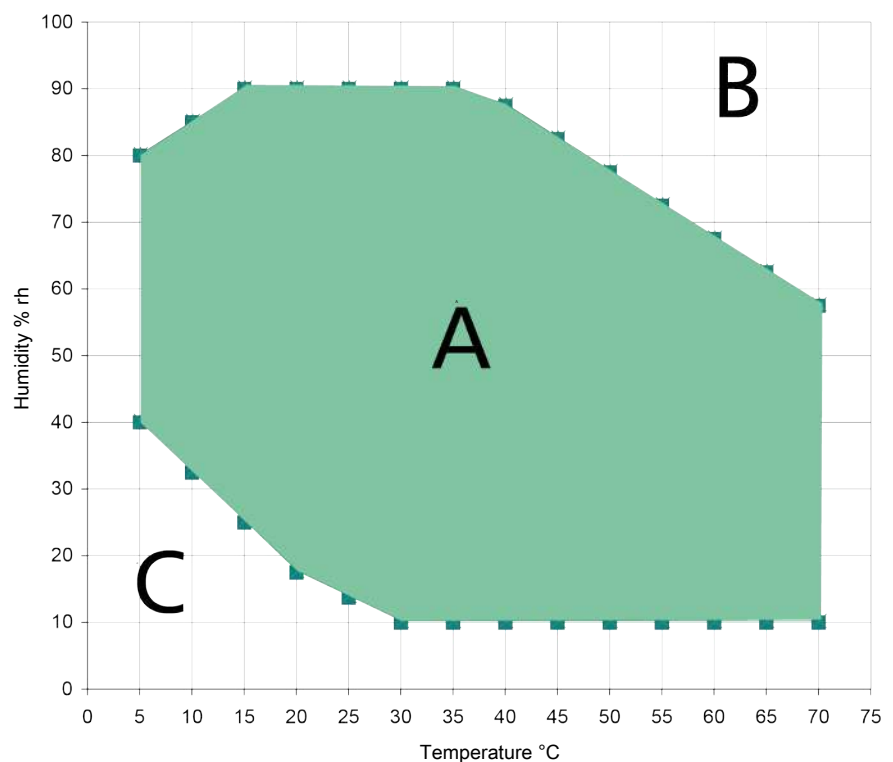

A In this range, any combination of temperature and humidity is possible without resulting in any significant condensation. In extreme ambient conditions, the working range may be restricted.

C At low temperatures and low relative air humidities, the effective range is heavily dependent on the humidity of the chamber load.

B If the upper limit of the specified range is exceeded, e.g. 80% rh at 60 °C, the hot incoming steam will immediately condense at the coldest point in the appliance upon reaching the dew point.

3.3 Materials

Components	Material
Housing (lid + side panels)	Stainless steel 1.4301 – ASTM 304
Housing (back panel)	Galvanised steel plate
Chamber (incl. cover)	Stainless steel 1.4301 – ASTM 304
Accessories (perforated shelf, grid)	Stainless steel 1.4301 – ASTM 304
Door seal	Silicone
Inner glass door	Glass
Insulation	2K foam

The chamber load of the appliance must be carefully checked for chemical compatibility with the above materials. A material resistance table can be requested from the manufacturer.



The chamber load of the unit must be carefully checked for chemical compatibility with the above materials.

3.4 Electrical Equipment

- Operating voltage and current consumption: See ▶3.6 Nameplate or ▶3.7 Technical Data
- Degree of protection IP 20 acc. to DIN EN 60529
- Protection class I, i.e. operating insulation with PE terminal in accordance with EN 60664-1
- Interference suppression acc. to EN 55011 class B

See also

- 📄 Technical Data [▶ 16]
- 📄 Nameplate [▶ 15]

3.5 Connections and Interfaces

3.5.1 Electrical Connection

This unit is designed for operation on an electrical power system with a maximum system impedance Z_{max} at the point of transfer (service line) of 0.292 Ohm. The operator must ensure that the unit is only operated on an electrical power system that meets these requirements.

If necessary, ask your local utility company what the system impedance is. Observe the country-specific regulations when making connections (e.g. in Germany DIN VDE 0100 with earth leakage circuit breaker).

Interior socket – option R3

The optionally available interior socket (option R3) is a power supply in the interior for connecting electrical devices brought in by the customer.

The load at the mains output socket must not exceed 230 V/2.2 A/500 W.

3.5.2 Communication Interfaces

The communication interfaces are intended for units which meet the requirements of IEC 62368-1.

Ethernet interface



You will find a description of how to transfer programs via Ethernet in the AtmoCONTROL software manual.

The unit can be connected to a network via the Ethernet interface, so that you can transfer programmes created with the AtmoCONTROL software to the unit and export logs.

For identification purposes, each unit connected must have its own unique IP address. A description of how to set the IP address is provided in chapter ▶8.3.2 IP Address and Subnet Mask.

The unit can be directly connected to a computer / laptop using an optional USB to Ethernet converter (see ▶3.10 Scope of Delivery).

USB interface

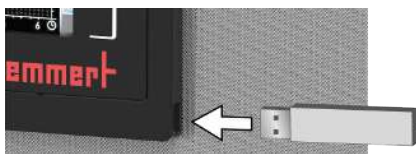

The unit comes with a USB port as standard in accordance with the USB specification. With this you can:

- transfer software stored on a USB storage medium to the unit (see ▶8.6 Programme)
- export logs from the unit to a USB storage medium (see ▶8.8 Log)
- transfer user ID data stored on a USB storage medium to the unit (see ▶8.9 USER ID)

The USB port is located on the right of the ControlCOCKPIT.

See also

- IP Address and Subnet Mask [▶ 48]
- Scope of Delivery [▶ 19]
- Programme [▶ 56]
- Log [▶ 58]
- USER ID [▶ 58]

3.6 Nameplate

The nameplate provides information about the appliance model, manufacturer and technical data. It is attached to the front of the appliance, on the right behind the door (see ▶3.1 Design).

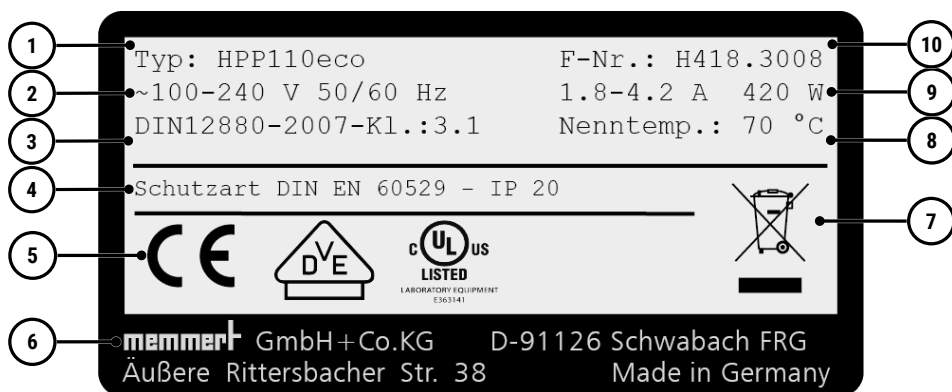

1 Type designation	2 Operating voltage
3 Applicable standard	4 Degree of protection
5 Conformity	6 Manufacturer's address
7 Information regarding disposal	8 Temperature range

9 Connected loads / power ratings

10 Appliance number

See also
 Design [▶ 11]

3.7 Technical Data

Appliance size			110	260	410	750	1060	1400	2200
Stainless steel interior	Volume	l	108	256	384	749	1060	1360	2140
	Width	A mm	560	640	640	1,040	1,040	1,250	1,972
	Height	B mm	480	800	1,200	1,200	1,200	1,450	1,450
	Depth	C mm	400	500	500	600	850	750	750
	Max. number of shelves	Pc	5	9	14	14	14	28	42
	Max. loading per shelf	kg	20	20	20	30	60	30	30
	Max. loading per appliance	kg	150	200	200	200	200	250	330
	Max. loading per insertable/removable drip tray	kg	3	4	4	8	8	-	-
	Max. loading per bottom drip tray	kg	3	4	4	8	8	-	-
Patterned stainless steel housing	Width	D mm	745	824	824	1,224	1,224	1,435	2,157
	Height	E mm	864	1,720	1,913	1,183	1,720	1,720	1,913
	Depth	F mm	555	655	655	755	1,005	905	905
Temperature	Operating temperature range without light, without humidity	°C	0 (at least 20 below room temperature) up to +70						
	Operating temperature range without light, with humidity	°C	+5 (at least 20 below room temperature) up to +70					+15 up to +60	
	Operating temperature range with light, with humidity	°C	+15 up to +40				-		
	Setting temperature range without light, with humidity	°C	+5 up to +70					+15 up to +60	
	Setting temperature range with light, with humidity	°C	+5 up to +70				-		
	Setting temperature range with light; without humidity	°C	0 up to +70				-		
	Setting temperature range without light, without humidity	°C	0 up to +70						
	Adjustment precision	°C	0.1						
Humidity	Humidity setting range without light	% rh	10 up to 90					10 up to 80	
	Humidity setting range with light	% rh	10 up to 90				-		
	Adjustment precision	% rh	0.5						
Further data	Peltier elements in the back panel	Pc	1	2	2	4	4	4	6
Packaging data	Net weight	kg	64	142	101	213	259	347	474
	Gross weight	kg	87	140	192	279	339	525	718
	Width	mm	830	930	930	1,330	1,370	1,560	2,300
	Height	mm	1,050	1,380	1,930	1,910	1,970	2,200	2,200
	Depth	mm	800	930	930	1,050	1,300	1,190	1,190

Performance data wide-range voltage input										
Electrical data	Power consumption	100-240 V	W	420	700	700	1,400	1,400	1,400	-
	Power consumption 50/60 Hz	200-240 V	W	-						2,000
	Max. current consumption 50/60 Hz	100-240 V	A	1.8 - 4.5	7.5 - 3.0	3.0 - 7.5	5.9 - 14.0	5.9 - 14.0	5.9 - 14.0	-
	Max. current consumption 50/60 Hz	200-240 V	A	-						8.4 - 10.0

Performance data fixed voltage input										
Electrical data	Power consumption 50/60 Hz	230 V	W	- ¹	700	700	1,400	1,400	1,400	2,000
	Max. current consumption 50/60 Hz	230 V	A	- ¹	3.1	3.1	6.1	6.1	6.1	8.7

Performance data with optional interior socket (option R3)										
Electrical data	Power consumption 50/60 Hz	200-240 V	W	920	1,200	1,200	1,900	1,900	-	-
	Max. current consumption 50/60 Hz	200-240 V	A	3.7 - 4.5	4.8 - 5.8	4.8 - 5.8	7.6 - 9.2	7.6 - 9.2	-	-

¹ alternative switched mode power supply is not required for size 110

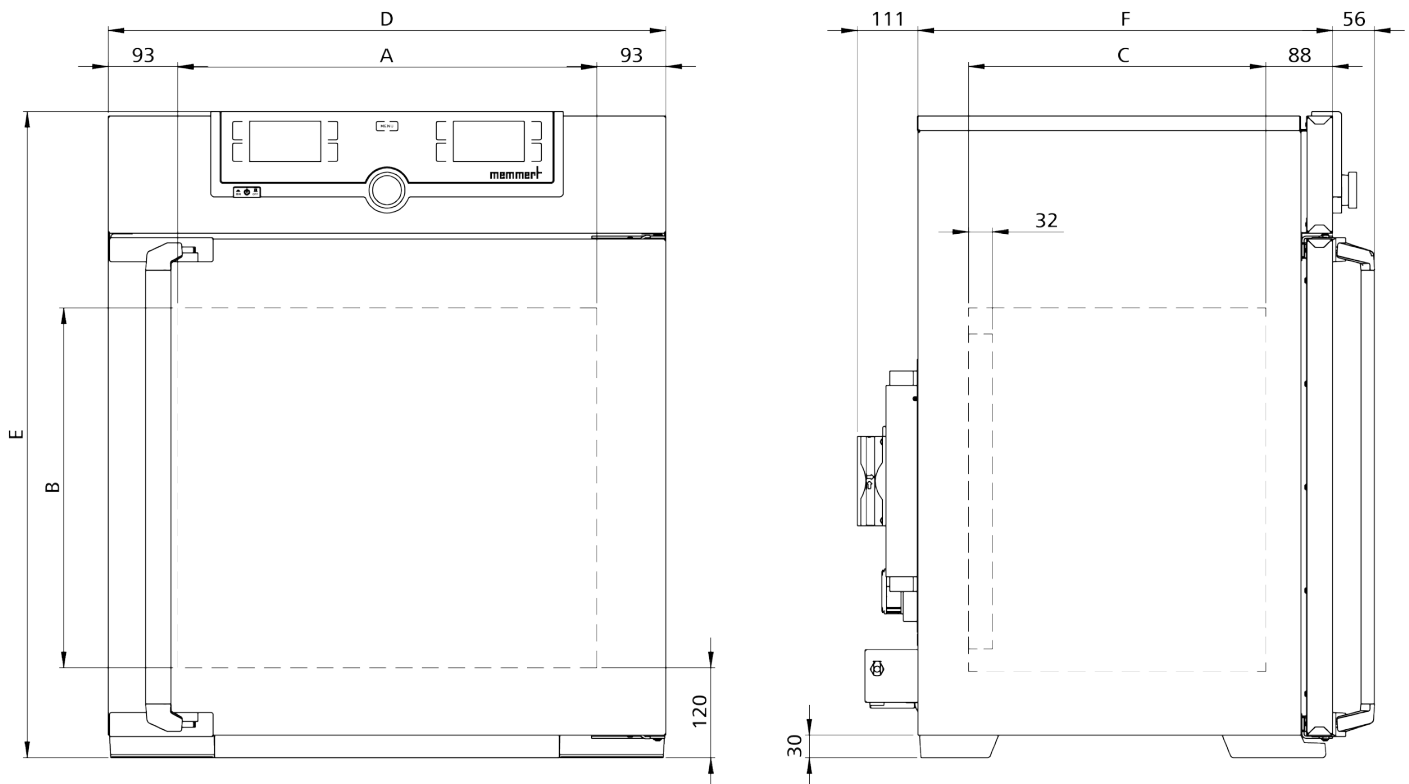

3.8 Applied Directives and Standards

3.8.1 Declaration of Conformity



You can download the EC declaration of conformity of the appliance online:

English: <http://www.memmert.com>

German: <http://www.memmert.com>

Based on the standards and guidelines listed below, the products described in this manual carry a CE mark from Memmert:

Low Voltage Directive 2014/35/EU

- EN 61010-1:2010, EN 61010-1:2010/A1:2019/AC:2019-04, EN 61010-1:2010/A1:2019; EN IEC 61010-2-010:2020

EMC-Directive 2014/30/EU

Directive 2014/30/EU with amendments (Council Directive on the approximation of the laws of the Member States relating to electromagnetic compatibility). Standards complied with:

- EN 61326-1:2013

Directive 2011/65/EU

Directive 2011/65/EU of the European Parliament and of the Council on the restriction of the use of certain hazardous substances in electrical and electronic equipment.

3.8.2 Material Compliance

We confirm that we always draw the attention of our suppliers to the legal restrictions on materials in accordance with our **Company Standard for Material Compliance of Memmert GmbH + Co KG** to ensure they take the original publications by the legislative authority into consideration at all times. The suppliers and deliveries must comply with all material compliance requirements which are relevant or specified in the company standard. By taking this approach, and by making our own observations, we are always able to stay abreast of developments to the best of our knowledge and ability.

In accordance with the REACH regulation and the RoHS guideline, Memmert provides information on the chemical substances in Memmert appliances online at:

www.memmert.com

3.8.2.1 REACH information of Memmert GmbH + Co. KG acc. to Regulation (EG) No. 1907/2006, Art. 33

Based on current knowledge, we confirm that products or sub-products containing substances of very high concern (SVHC in the specified components) in the Candidate List with concentrations higher than 0.1 mass % are installed in the appliances we supply:

Appliance component	Substance in the Candidate List SVHC	CAS No.
PTC heating elements	Lead	■ 7439-92-1
Peltier elements	Antimony trioxide	■ 1309-64-4
Blue housing protection film	Tris(4-nonylphenyl, branched and linear) phosphite	■ 26523-78-4 ■ 3050-88-2 ■ 31631-13-7 ■ 106599-06-8
Seal inserts made of NBR	2,2'-Methylenbis(4-methyl 6-tert-butylphenol)	■ 119-47-1

3.8.2.2 RoHS Information of Memmert GmbH + Co. KG acc. to Directive 2011/65/EU and Delegated Directive 2015/863

We confirm that we comply with the substance restrictions in accordance with 2011/65/EU for the supplied products, accessories and spare parts. With regard to the substance lead, we and/or our suppliers make use of the applications exempted from the restriction for lead stated in appendix III in a credible, trustworthy manner.

3.9 Ambient Conditions

- The unit must only be used in closed rooms and in the ambient conditions listed below:

Ambient temperature	16 °C to 40 °C
Air humidity	max. 70% non-condensing
Overvoltage category	II
Contamination level	2
Installation altitude a.s.l.	max. 2000 m a.s.l.
Maximum mains voltage fluctuations	AC 100–240 V (± 10%)

- The unit may not be used in Ex zones. The ambient air must not contain explosive dusts, gases, vapours or gas-air mixtures. The unit is not explosion-proof.
- Heavy dust production or aggressive vapours in the vicinity of the unit could lead to sedimentation in the interior and, as a consequence, could result in short circuits or damage to electrical parts. For this reason, sufficient measures to prevent large accumulations of dust or aggressive vapours should be taken.

3.10 Scope of Delivery

Standard delivery

- Mains connection cable
- Anti-tilt bracket
- Grid (number depending on the appliance size)
- USB storage medium with software and AtmoCONTROL manual
- Operating manual
- Calibration certificate
- Water tank with connection hose
- Tank holder (only for appliances from size 410)

Optional accessories

- Ethernet to USB converter. Makes it possible to connect the Ethernet port of the appliance to the USB port of a computer/laptop.
- Reinforced grid with a load capacity of 60 kg (from appliance size 110).

4. Delivery, Transport and Setting Up

4.1 Safety

⚠ CAUTION



Lifting the appliance incorrectly

The appliance is heavy. The appliance is heavy, so you could injure yourself if you try to lift it on your own.

- Make sure that a sufficient number of people are on hand to lift and carry the appliance.
- Larger appliances must not be carried, and only transported by pallet truck or forklift truck.

110	260	410	750	1060	1400	2200

⚠ CAUTION



Crushing hazard due to heavy equipment

The unit is heavy. Crushing injuries to hands or feet can occur when transporting and installing the unit.

- Wear protective gloves and safety boots.
- Grab hold of the sides of the unit to carry it.

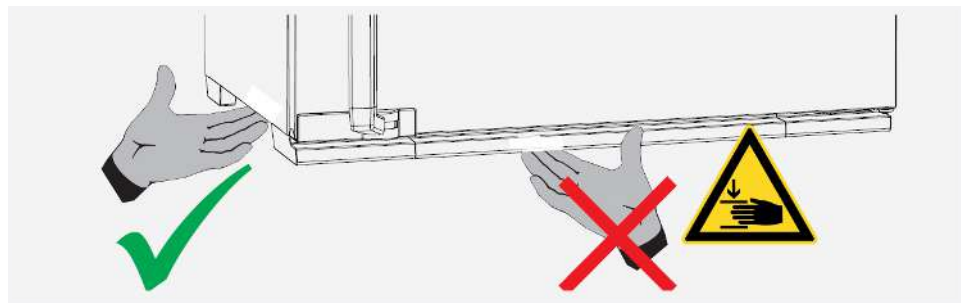

⚠ CAUTION



Risk of injury due to the appliance falling over during transport

The appliance is heavy. The appliance could fall over and seriously injure you.

- Never tilt the appliance and only transport it in the upright position without load (except for standard accessories such as grids or shelves).
- Appliances with castors always have to be moved by at least two people.

4.2 Delivery

Appliance size 110 to 1060

- The appliance is supplied packed in cardboard on a wooden pallette.

Appliance size 1400 to 2200

- The appliance is supplied packed in a wooden crate on a wooden pallette.

4.3 Transport

The unit can be transported in different ways depending on its size:

- With a forklift truck or pallet truck; move the forks of the truck entirely under the pallet
- Carrying; lift the unit at the designated handle positions
- If the appliance has its own castors, also release the locking device on the (front) castors

4.4 Unpacking

- Do not unpack the appliance until you reach the installation site.
- Remove the cardboard packaging by pulling it upwards or carefully cutting along an edge or unscrew and remove wooden crate.

Checking for completeness and transport damage

- Check the delivery note to ensure the delivery is complete.
- Check the unit for damage.

If you notice deviations from the scope of delivery, damage or anything unusual, do not put the unit into operation and inform the haulage company and the manufacturer.

Removing the transportation lock

- Remove the transportation lock. It is located between the door hinge, door and frame and has to be removed after opening the door.

Disposing of packaging material

- Dispose of the packaging material (cardboard, wood, foil) in accordance with the applicable disposal regulations for the respective material in your country.

4.5 Storage after Delivery

If the unit is initially to be stored after delivery:

- Observe storage conditions (see ▶10.1 Storage and Transport)

See also

📄 Storage and Transport [▶ 62]

4.6 Setting Up

⚠️ WARNING



Danger of tipping due to the appliance's centre of gravity

Due to its centre of gravity, the appliance could tip forwards and injure you or someone else.

- Always attach the appliance to a wall with the anti-tilt bracket.
- In case there is not enough space to fasten the appliance to a wall, do not put the appliance into operation and do not open the door.
- Contact Memmert service.

4.6.1 Preconditions

- ✓ The installation site must be flat and horizontal and must be able to reliably bear the weight of the unit (see ▶3.7 Technical Data). Place the unit on a heat-resistant, fireproof and non-flammable surface.

- ✓ A 230 V or 115 V power connection must be available at the installation site, depending on the version (see ▶3.6 Nameplate).
 - ✓ The distance between the wall and the rear panel of the appliance must be at least 15 cm.
 - ✓ The clearance from the ceiling must not be less than 20 cm and the side clearance from walls or nearby appliances must not be less than 5 cm. Sufficient air circulation in the vicinity of the appliance must be guaranteed at all times.
 - ✓ For appliances with castors or for appliances standing on sub frames with castors, always position the castors in a forward direction and lock the castor brakes to ensure that the appliances remain securely in place.
- ▶ Place the unit in the designated position as shown below.

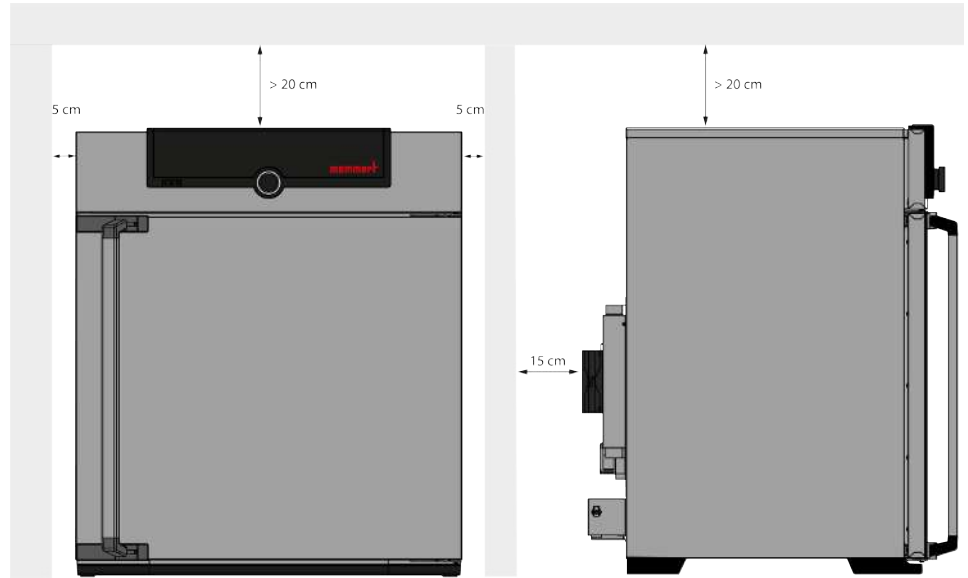

See also

- 📄 Technical Data [▶ 16]
- 📄 Nameplate [▶ 15]

4.6.2 Installation Options

Setting up		Comments	110	260	750	1400
				410	1060	2200
Floor			✓	✓	✓	✓
Table		Check the load-bearing capacity first	✓	✗	✗	✗
Stacked		No more than two appliances; mounting material (feet) provided	✓	✗	✗	✗
Sub frame		with/without castors	✓	✓	✗	✗

Setting up	Comments	110	260 410	750 1060	1400 2200
Castor frame		✓	✓	✗	✗
Height-adjustable feet		✓	✓	✓	✓

4.6.3 Levelling the Appliance



Levelling must only be carried out when setting up appliance sizes 1400 and 2200. For all other appliance sizes, you can skip this chapter and continue under ▶4.6.4 Anti-tilt bracket.

The appliance can be levelled by adjusting the height of the heavy-duty castors on the bottom of the appliance. It can also be secured to prevent it rolling away or being shifted. To do this, the feet must be extended.

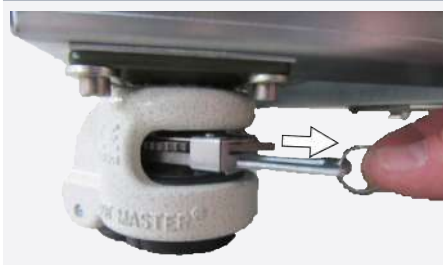

1. To unlock the adjustment mechanism, pull out the ratchet lever on the ring.

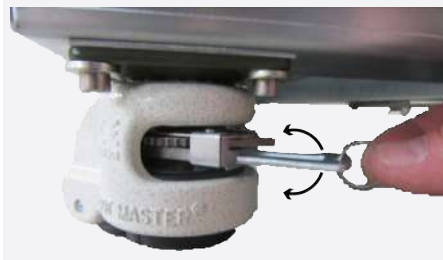

2. To retract and extend the foot, actuate the ratchet lever.



3. The direction of movement (up/down) can be adjusted using the rocker above the ratchet lever:

- Press in the rocker on the right side to extend the foot with the ratchet lever.
- Press in the rocker on the left side to retract the foot with the ratchet lever.



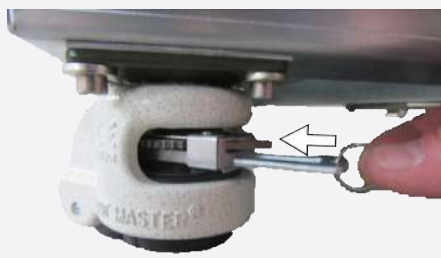

4. In the end position, push the ratchet lever in again to fix the foot.



Use a spirit level to ensure that all four feet are adjusted to the same height. To move the cabinet, all four feet must be retracted.

See also

Anti-tilt bracket [► 24]

4.6.4 Anti-tilt bracket

NOTICE



Two anti-tilt brackets are included with the 1400 and 2200 appliance sizes. To ensure stability, both anti-tilt brackets must be attached.

Attach the appliance to a wall with the anti-tilt bracket. The anti-tilt bracket is included in the scope of delivery.

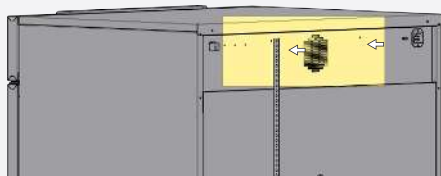

1. Screw the anti-tilt bracket to the back of the appliance as illustrated.



Depending on the ambient conditions, the anti-tilt bracket can be fastened at one of the two holes provided in the appliance.

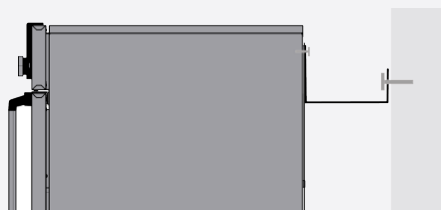

2. Bend the anti-tilt bracket up by 90° to achieve the required clearance from the wall (observe the minimum clearance).

3. Find a suitable wall, drill a hole, insert a plug and screw on the anti-tilt bracket.

4.6.5 Adjusting the Doors

You can adjust the doors if necessary, for example if they are warped due to uneven flooring. There are two adjusting screws on each door for this purpose; one at the top and one at the bottom.

First, adjust the setting at the top of the door and, if this is not sufficient, adjust the bottom.



A service video which explains how to adjust the door is available: www.memmert.com/de/downloads/media/service-videos/

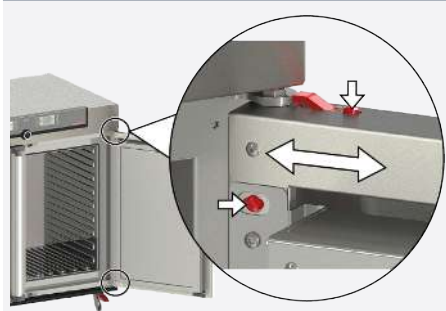

1. Open the door.
2. Loosen the screws.
3. Adjust the position of the door.
4. Tighten the screws again.
5. Check the position of the door.
6. Readjust if required.

5. Putting into Operation

5.1 Putting into Operation for the First Time

⚠ WARNING



Condensation in the electrical components may cause short circuits.

Due to temperature fluctuations during transport, condensation may form inside the unit.

- After transporting or storing the unit in humid conditions, remove it from its packaging and allow it to acclimatise for at least 24 hours in normal ambient conditions.
- Do not connect the unit to the power supply during this time.

NOTICE



When putting the unit into operation for the first time, do not leave it unattended until it has reached a steady state.

- Please observe the national regulations when connecting the unit.
- Observe the connected loads and power ratings (see ▶3.6 Nameplate and ▶3.7 Technical Data).
- Be sure to establish a safe PE conductor connection.

See also

- 📄 Nameplate [▶ 15]
- 📄 Technical Data [▶ 16]

5.2 Connecting the Unit to the Power Supply



Route the power cable so that

- nobody can trip over it.
- it cannot come into contact with any hot parts.
- it is easily accessible at all times and the plug can be pulled out quickly in the event of a fault or emergency, for example.

5.3 Water specifications

Only water with the following specifications may be used in Memmert units:

- Demineralised water and distilled water (a variety of terms are used commercially for this) that is residue-free when it evaporates, according to regulation VDE 0510 and DIN 43530
- Conductivity of approx. > 1 ; $< 10 \mu\text{S}/\text{cm}$
- neutral pH value (between 5 and 7)
- Chlorine-free

The use of double-distilled water / ultrapure water / other highly purified water (a variety of terms are also commonly used) with an electrical conductance below about $< 1 \mu\text{S}/\text{cm}$ must be avoided. The use of such water is not necessary and could damage the unit by corroding metallic components on and in the unit. Unsuitable water with an electrical conductance greater than $10 \mu\text{S}/\text{cm}$ will damage the unit due to the residues that occur during evaporation and vaporisation, including the formation of limescale deposits.

5.4 Connecting and Filling the Water Tank

For size 410 appliances or higher: The water tank can be attached to the appliance using the supplied mounting bracket as follows:

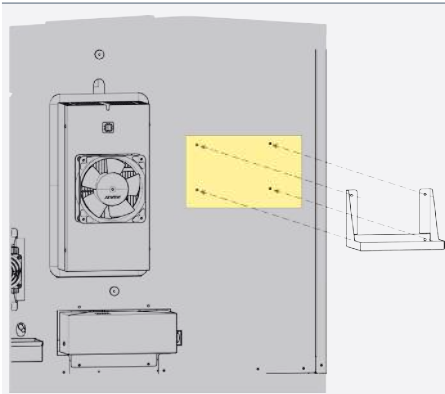

1. To do this, fasten the tank mounting bracket to the back panel using four screws.

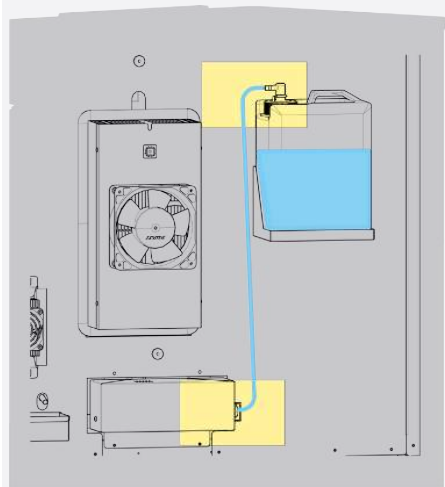

2. Fill the water tank with water.
3. Connect the water tank to the steam generator.

5.5 Hook in Drip Pan

Holders for the drip pan are next to each Peltier dehumidifier. The drip pan is attached by lowering it on to the holders from above.

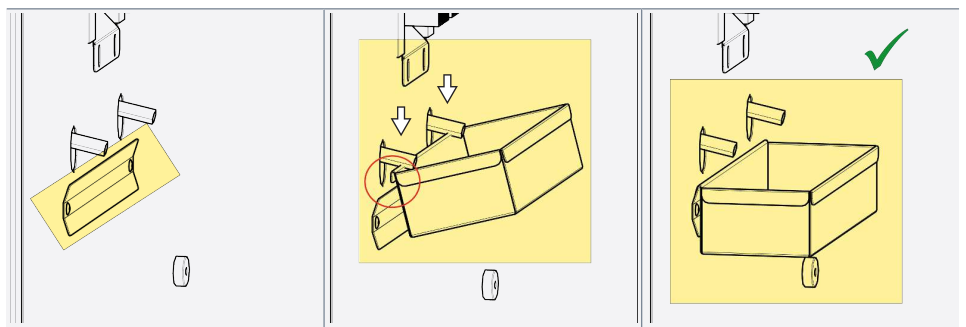

5.6 Switching on Unit

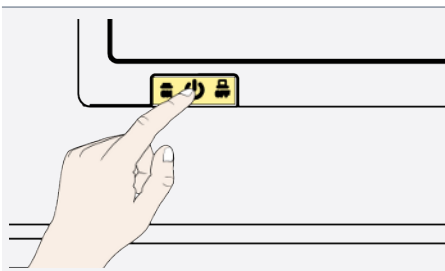

1. Switch on the appliance by pressing the main switch on the front of the appliance.
⇒ The starting process is shown by three animated white dots (see ▶7.1 Warning Message of the Monitoring Function).

If the dots have another colour, an error has occurred (see ▶7 Malfunctions, Warning and Error Messages).



After the first start-up, the appliance display is set to English by default.

You can change the language as described in chapter ▶8.2 Basic Operation in Menu Mode Using the Example of Language Selection. However, to get a basic overview of operating the appliance, you should read the following chapter first.

See also

- 📄 Basic Operation in Menu Mode Using the Example of Language Selection [▶ 46]
- 📄 Warning Message of the Monitoring Function [▶ 43]
- 📄 Malfunctions, Warning and Error Messages [▶ 43]

6. Operation and Control

6.1 Operating Personnel

The appliance may only be operated by persons who are of legal age and have been instructed accordingly. Personnel who are to be trained, instructed or who are undergoing general training may only work with the appliance under constant supervision of an experienced person.

6.2 Opening the Door

⚠ DANGER



Danger of suffocation inside the appliance

If the appliances is a certain size, you can get accidentally locked in, which is potentially life-threatening.

- Do not climb into the appliance.
- Do not carry out cleaning work in the chamber alone.

⚠ WARNING



Overheating of the appliance when door is open

Leaving the door open during operation can cause the appliance to overheat or pose a fire hazard.

- Do not leave the door open during operation.

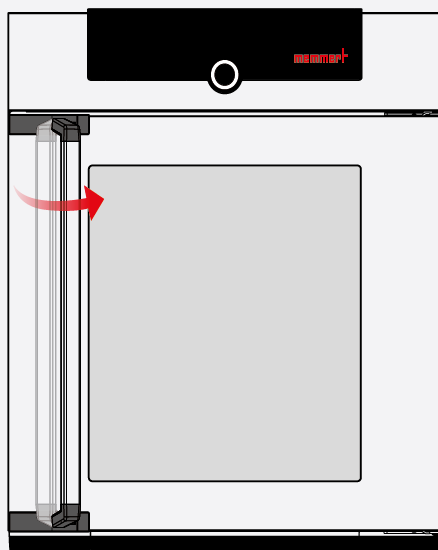

1. To open the door, pull the door handle to the side.

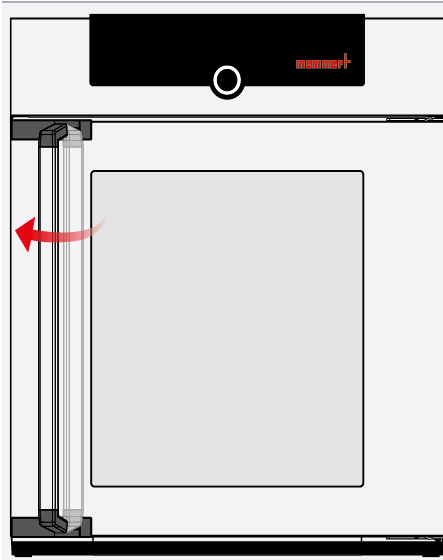

2. To close the door, push the door closed and push the door handle to the side.

6.3 Loading the Appliance

⚠ WARNING



Poisonous or explosive vapours and gases

When loading the unit with an unsuitable load, poisonous or explosive vapours or gases may be produced. This could cause the unit to explode, and persons could be severely injured or poisoned.

- The unit may only be loaded with materials and substances which cannot form any toxic or explosive vapours at the set temperature and which cannot explode, burst or ignite.

NOTICE



Chemical compatibility of the chamber load

Chemical incompatibility may result in damage to the appliance.

- Check the chamber load for chemical compatibility with the materials of the appliance (see ▶3.3 Materials).



Insert the metal grids or shelves. The maximum number of grids / shelves and the load capacity are specified in the ▶3.7 Technical Data.

- To achieve the most efficient temperature distribution, the type of insert used – grid or shelf – has to be set in the menu under **SETUP**.

The appliance must not be loaded too densely to ensure that air can circulate freely inside the chamber. If the chamber loading is unfavourable (chamber too densely packed), the set temperature may be exceeded or it may take longer until it is reached.

- Do not place any of the chamber load on the bottom, touching the side walls or right below the ceiling of the chamber.
- See also the “correct loading” sticker on the appliance.

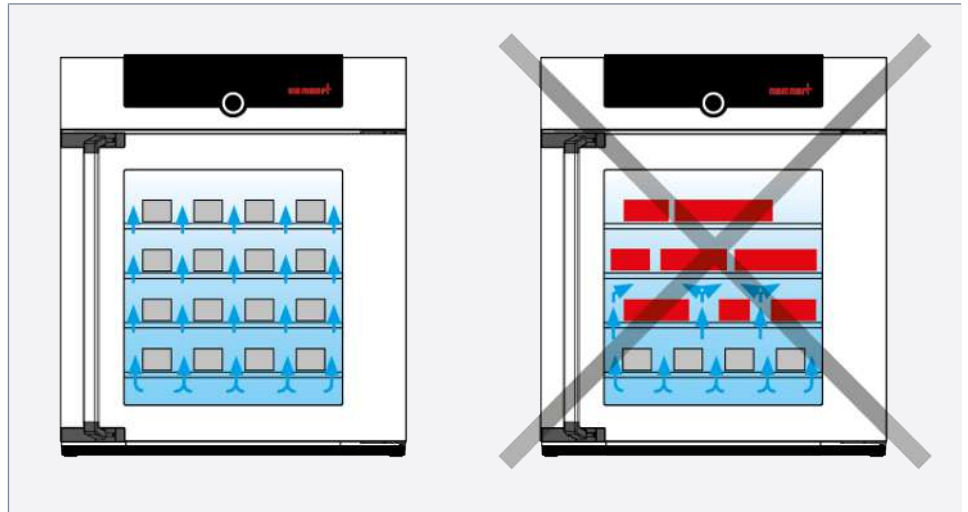

See also

- ▣ Materials [▶ 14]
- ▣ Technical Data [▶ 16]

6.4 Operating the Appliance

6.4.1 ControlCOCKPIT

In manual operation, the desired parameters are entered at the ControlCOCKPIT on the front of the appliance. You can also make basic settings here (**menu mode**). Warning messages are also displayed, e.g. if the temperature is exceeded. In programme mode, the parameters defined, the programme description, the programme segment currently active and remaining programme runtime are displayed.

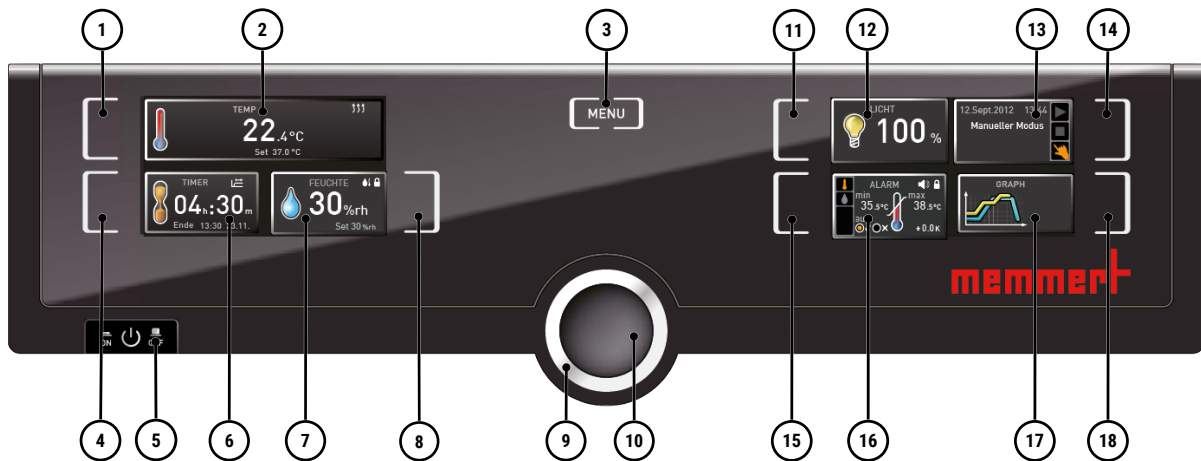

1	Activation key for temperature setpoint input	2	Setpoint and actual temperature display
3	Menu key	4	Activation key for digital backwards counter with target time setting
5	Main switch	6	Digital backwards counter display with target time setting
7	Humidity control display	8	Humidity control activation key
9	Turn control for setpoint adjustment	10	Confirmation key
11	Activation key for adjustment of interior lighting (only for models with light cartridge)	12	Interior lighting display (only for models with light cartridge)
13	Appliance state and programme display	14	Activation key for the appliance state

15	Activation key for adjustment of temperature monitoring	16	Monitoring display
17	Graphic representation	18	Activation key for graphic representation

6.4.2 Basic Operation

In general, all settings are made as follows:

	<p>Activate the desired parameter (e.g. temperature):</p> <ol style="list-style-type: none"> To do so, press the activation key to the left or right of the respective display. <ul style="list-style-type: none"> ⇒ The activated display is outlined in colour, the other displays are dimmed. ⇒ The setpoint value (Set) is highlighted in colour.
	<ol style="list-style-type: none"> To adjust the setpoint value (e.g. to 37.0 °C), turn the turn control clockwise or anti-clockwise.
	<ol style="list-style-type: none"> Save the set value by pressing the confirmation key. <ul style="list-style-type: none"> ⇒ The display returns to normal and the appliance starts controlling with reference to the defined setpoint value. ⇒ Additional parameters and functions (pressure) can be set accordingly.
	<p>If no new values are entered or confirmed for approx. 30 seconds, the appliance automatically restores the former values.</p>
	<p>If you want to discard the settings:</p> <ol style="list-style-type: none"> Press the activation key on the left or right of the display that you want to exit. <ul style="list-style-type: none"> ⇒ The appliance restores the former values. ⇒ Only the settings that you have saved by pressing the confirmation key will be applied.

6.5 Operating Modes

Manual mode

The appliance runs continuously with the values set at the ControlCOCKPIT.

- See ▶6.5.1 Manual Mode

Timer mode

Operation with digital backwards counter with target time setting, adjustable from 1 minute to 99 days (Timer): The appliance runs at the values set until the set time has elapsed.

- See ▶6.5.2 Digital Backwards Counter

Programme Mode

The appliance automatically runs programme sequences which have been defined using AtmoCONTROL software at a computer / laptop and then transferred to the appliance from a USB stick or via Ethernet.

- See ▶6.5.3 Programme Mode

Remote control mode

Via remote control

- See ▶8.3.8 Remote Control

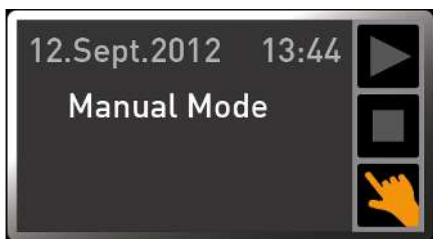

The status display shows the current operating mode or operating state of the appliance. The current operating state is indicated by colour and text display:

- ▶ Appliance is in programme mode
- Programme stopped
- ✋ Appliance is in manual mode

The example on the right shows the appliance in manual mode, as indicated by the coloured hand symbol.

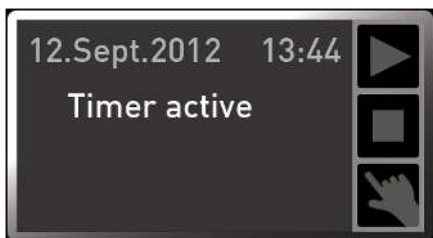

When the appliance is in timer mode, Timer active is displayed.

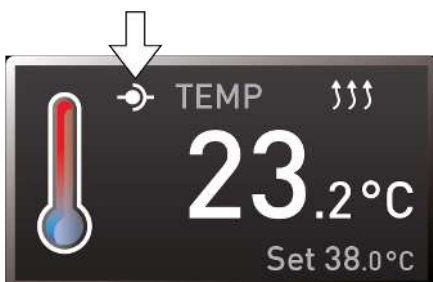

When the appliance is in remote control mode, the symbol appears in the temperature display.

See also

- Manual Mode [▶ 33]
- Digital Backwards Counter [▶ 34]
- Programme Mode [▶ 35]
- Remote Control [▶ 51]

6.5.1 Manual Mode

In this operating mode, the appliance runs continuously with the values set on the ControlCOCKPIT.

As described in chapter ▶6.4.2 Basic Operation, you can set the following parameters after pressing the corresponding activation key (in any sequence):

Temperature



Heating operation is indicated by the symbol.

Cooling is indicated by the symbol.

You can display the temperature in °C or °F.

Adjustment range depends on appliance (see ▶3.6 Nameplate and ▶3.7 Technical Data).



The minimum temperature that can be reached depends on the ambient conditions. The devices can cool down to 20 °C below room temperature. For this purpose, the Peltier module needs sufficient ventilation.

Humidity



Setting range, see ▶3.7 Technical Data
 Humidification is indicated by the symbol.
 Dehumidification is indicated by the symbol.



A high air humidity in the chamber can only be achieved without condensation if the chamber is thoroughly heated. For this reason, the rate at which the humidity is dynamically adjusted to the setpoint depends on the chamber temperature.

Interior lighting



This parameter can only be set for configurations with light cartridge.



The interior lighting is only active at temperatures up to 40 °C. If this temperature is exceeded, the interior lighting switches off automatically. The light display will then show “Temp too high”.



Adjustment options: 0 to 100% in 1% increments.

See also

- ▶ Basic Operation [▶ 32]
- ▶ Nameplate [▶ 15]
- ▶ Technical Data [▶ 16]
- ▶ Technical Data [▶ 16]

6.5.2 Digital Backwards Counter



In timer mode, you can adjust the time the appliance runs at the set value. The appliance has to be in manual operating mode for this.

Up to a duration of 23 hours 59 minutes, the time is displayed in hh:mm (hours:minutes) format. For 24 hours and more, the format dd:hh (days:hours) is used. The maximum duration is 99 days and 00 hours.

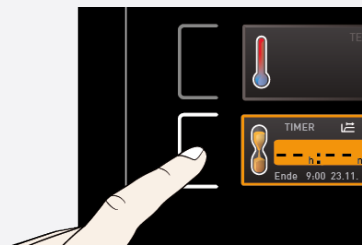

1. Press the activation key to the left of the timer display.
 ⇒ The timer display is activated.



2. Turn the turn control until the desired duration is displayed.
 ⇒ The anticipated end time is shown beneath, in smaller digits.

	<p>3. Press the confirmation key to confirm.</p> <ul style="list-style-type: none"> ⇒ The display now shows the remaining time in large digits and the anticipated end time in smaller digits beneath. ⇒ The status display shows "Timer active".
	<p>4. Now, as described in ▶6.4.2 Basic Operation, set the individual reference values to be used by the appliance during operation.</p> <ul style="list-style-type: none"> ⇒ The change takes effect immediately.
	<p>The set values can be changed at any time while the timer runs down.</p>
	<p>In Setup, you can choose if the timer should run setpoint-dependent or not, in other words, whether the timer should not start until a tolerance band around the setpoint temperature is reached or if it should start right after activation.</p> <p>The symbol on the timer display indicates that the timer is setpoint-dependent.</p>
	<p>Once the timer has elapsed, the display shows 00h:00m.</p> <ul style="list-style-type: none"> ■ All functions are switched off. ■ In addition, an alarm sounds, and can be turned off by pressing the confirmation key.
	<p>5. To switch off the timer, press the activation key again to display the timer.</p> <p>6. Turn the turn control to reduce the runtime until --:-- is displayed.</p> <p>7. Press the confirmation key to apply the setting.</p>

See also

Basic Operation [▶ 32]

6.5.3 Programme Mode

NOTICE



A description of how to create and save programmes can be found in the separate AtmoCONTROL software manual.

In this operating mode, programmes saved in the appliance can be started with different combinations of individual parameters with offset timings which the appliance then automatically processes in sequence.

These programmes are not created directly at the appliance but externally at a computer / laptop using the AtmoCONTROL software then transferred to the appliance using the provided USB storage medium or via Ethernet.

Starting a programme



1. Press the activation key to the right of the status display.
⇒ The current operating state is highlighted automatically, in this example **manual mode** (→).

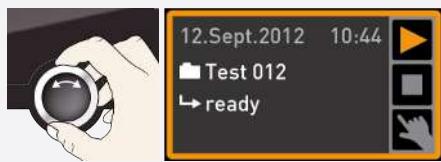

2. Turn the turn control until the ▶ start symbol is highlighted.
⇒ The currently available programme is displayed.



Only the programme currently selected in the menu and shown in the display can be used. If you want to run another programme, you need to activate it in the menu first (description in ▶8 Menu Mode).

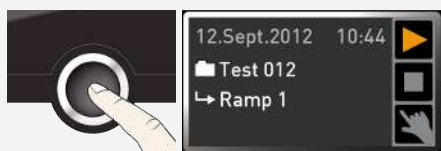

3. To start the programme, press the confirmation key.
⇒ The programme is executed.

The display shows:

- the programme name
- the name of the first programme segment
- the current cycle (in case of loops)



You cannot change any parameters at the appliance while a programme is running. However, you can still use the displays **ALARM** and **GRAPH**.

Cancelling a programme

You can cancel an active programme at any time:



1. Press the activation key to the right of the status display.
⇒ The status display is automatically highlighted.

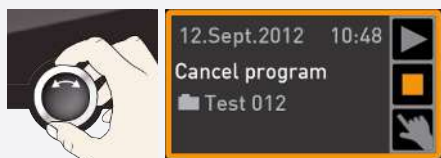

2. Turn the turn control until the stop symbol ■ is highlighted.

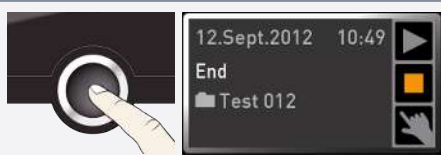

3. Press the confirmation key to confirm.
⇒ The programme is cancelled.



A cancelled programme cannot be resumed at the point it was cancelled. It must be restarted from the beginning.

End of programme

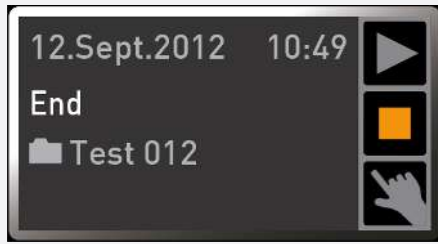

The **End** display appears once the programme has finished normally.



You can now

- restart the programme as described,
- select another programme to run in menu mode (see ▶8.6 Programme) and run it as described,
- return to manual mode. To do so, reactivate it by pressing the activation key next to the status display, then turn the turn control until the hand symbol is highlighted in colour and press the confirmation key.

See also

- 📄 Menu Mode [▶ 46]
- 📄 Programme [▶ 56]

6.6 Monitoring Function

6.6.1 Temperature Monitoring

The appliance is equipped with multiple overtemperature protection in accordance with DIN 12880. This is designed to prevent damage to the chamber load and/or appliance in case of a malfunction:

- electronic temperature monitoring (TWW)
- automatic temperature monitor (ASF)



The electronic temperature monitoring measures the monitoring temperature via a separate Pt100 temperature sensor in the chamber. Temperature monitoring settings are made via the **ALARM** display. The settings made apply to all operating modes.



If temperature monitoring has been triggered, this is indicated by the temperature display: the actual temperature is highlighted in red and a warning symbol is shown. The type of temperature monitoring that has been triggered is shown beneath the temperature (see ▶ 7 Malfunctions, Warning and Error Messages).

The individual monitoring functions will be presented in more detail first, followed by a description of how to set the temperature monitoring.



If the acoustic signal has been activated at Alarm in menu mode (▶8.7 Acoustic Signals, which is indicated by the speaker symbol) , the alarm will be accompanied by an intermittent acoustic signal.

The acoustic alarm can be temporarily switched off by pressing the confirmation key until the next alarm event occurs.

See also

- ▣ Malfunctions, Warning and Error Messages [▶ 43]
- ▣ Acoustic Signals [▶ 57]

6.6.2 Electronic Temperature Monitoring (TWW)

The manually set min and max monitoring temperature of the electronic overtemperature protection is monitored by a temperature selector switch (TWW) protection class 3.3 acc. to DIN 12880.

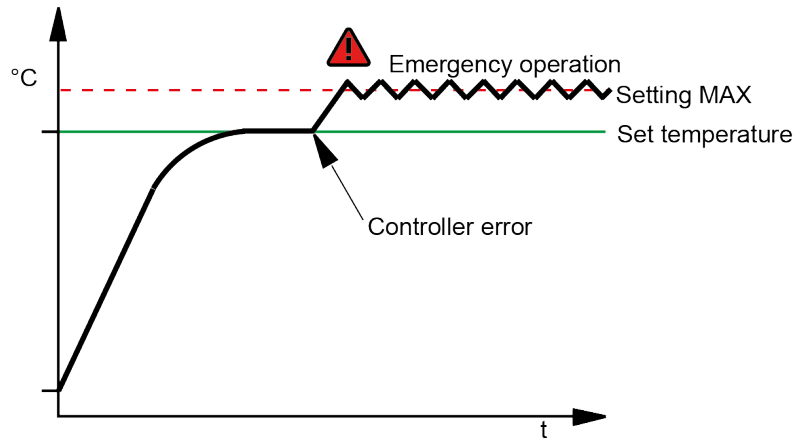

6.6.3 Automatic Temperature Monitor (ASF)

ASF is a monitoring device that automatically follows the set temperature setpoint within an adjustable tolerance band.

The ASF – if switched on – is automatically activated as soon as the actual temperature value reaches 50% of the set tolerance band of the setpoint for the first time (section A).

When the temperature leaves the set tolerance band around the setpoint – e.g. if the door is opened during operation (section B) – the alarm is triggered. The ASF alarm is automatically deactivated as soon as 50% of the set tolerance band of the setpoint has been reached again (section C).

If the temperature setpoint is altered, the ASF is automatically disabled temporarily (section D), until it is once again within the tolerance range of the new temperature setpoint (section E).

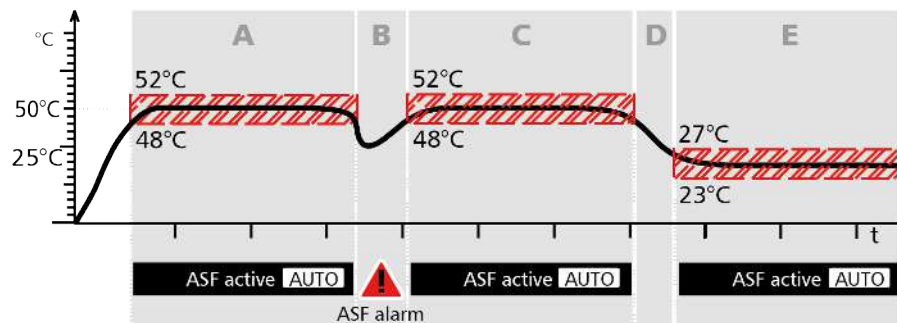

6.6.4 Adjusting the Temperature Monitoring



1. Press the activation key to the left of the **ALARM** display.
⇒ The temperature monitoring setting is automatically activated .

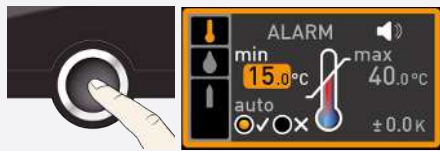

2. Confirm the selection by pressing the confirmation key.
⇒ The **min** setting (undertemperature protection) is automatically activated.



3. By turning the turn control, adjust the desired lower alarm limit.



The lower alarm limit cannot be higher than the upper alarm limit. If no undertemperature protection is required, set the lowest temperature.

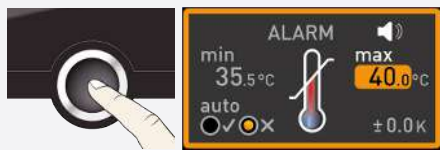

4. Press the confirmation key to confirm.
⇒ The **max** display (overtemperature protection) is activated.

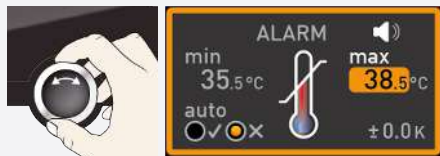

5. By turning the turn control, adjust the desired upper alarm limit.



The monitoring temperature must be set sufficiently high above the maximum setpoint temperature. We recommend 1 to 3 K.

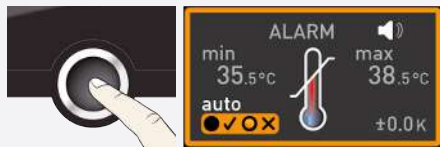

6. Press the confirmation key to apply the setting for the upper alarm limit.
⇒ The setting of the automatic temperature monitor (ASF) is automatically activated (**auto**).

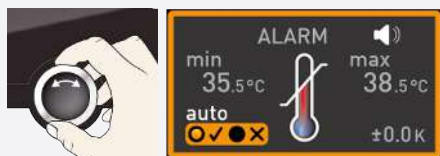

7. With the turn control select ON (✓) or OFF (X).

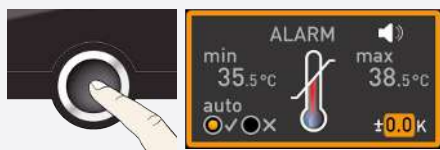

8. Press the confirmation key to confirm.
⇒ The ASF tolerance band setting is activated.

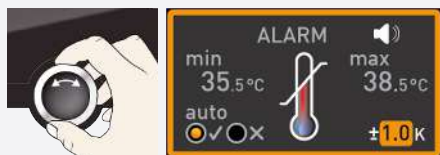

9. With the turn control, select the required tolerance band.



We recommend a tolerance band of 1 to 3 K.

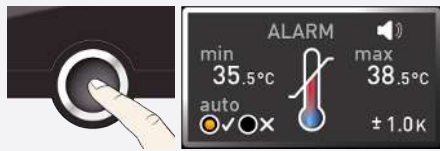

10. Press the confirmation key to confirm.
⇒ Temperature monitoring is now active.



In menu mode you can set, whether an alarm should be accompanied by an acoustic signal (see ▶8.7 Acoustic Signals).

See also

- Acoustic Signals [▶ 57]

6.6.5 Humidity Monitoring



If humidity monitoring has been triggered, this is indicated by the humidity display: the actual humidity is highlighted in red and is accompanied by a warning symbol ▲.

If the acoustic signal has been activated in Menu mode to accompany an alarm (▶ 8.7 Acoustic Signals, which is indicated by the speaker symbol 🔊), the alarm is accompanied by an intermittent acoustic signal. Information on what to do in this case is provided in the chapter ▶7 Malfunctions, Warning and Error Messages.

Adjusting humidity monitoring



1. Press the activation key to the left of the **ALARM** display.
⇒ The temperature monitoring setting is automatically activated.

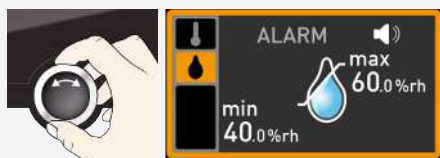

2. Turn the turn control until the humidity setting is highlighted.

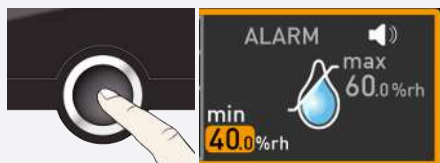

3. Confirm the selection by pressing the confirmation key.
⇒ The lower humidity alarm limit is automatically highlighted.

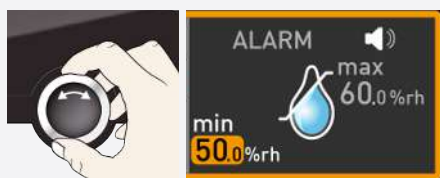

4. By turning the turn control, set the required lower alarm limit, 50% rh in the example on the left.

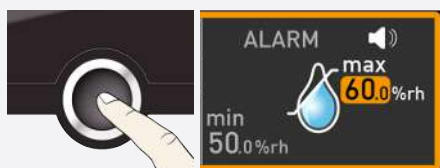

5. Confirm the selection by pressing the confirmation key.
⇒ The upper humidity alarm limit is automatically highlighted.

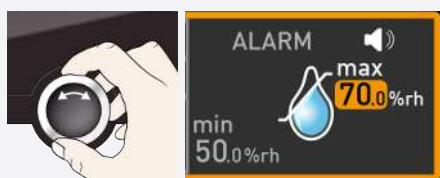

6. By turning the turn control, set the required upper alarm limit, 70 % rh in the example on the left.



7. Press the confirmation key to confirm.
 8. Press the activation key on the side to exit the Alarm display.
- ⇒ Humidity monitoring is now active.

See also

- ▣ Acoustic Signals [▶ 57]
- ▣ Malfunctions, Warning and Error Messages [▶ 43]

6.7 Graph



The **GRAPH** display provides an overview of the chronological sequence of the set values and the actual values as a curve.

- Press the activation key again to close the graphic display.

6.7.1 Temperature Curve



1. Press the activation key to the right of the **GRAPH** display.
- ⇒ The display is enlarged and the temperature curve is displayed.

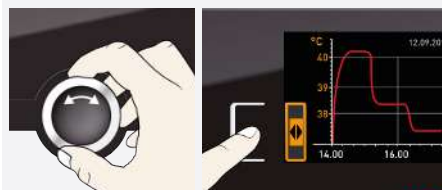

2. To change the time range to display press the activation key next to the ◀▶ arrow symbols.
- ⇒ The time range to display can now be displaced by turning the turn control.

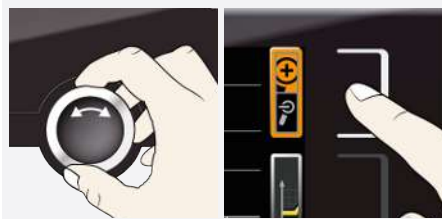

- To zoom in or out in the graph:
3. Press the activation key next to the magnifying glass symbol.
 4. With the turn control, select if you want to zoom in or out (+/-).
 5. and confirm your selection by pressing the confirmation key.
- ⇒ To close the graphic display, press the activation key again.

6.7.2 Humidity Profile

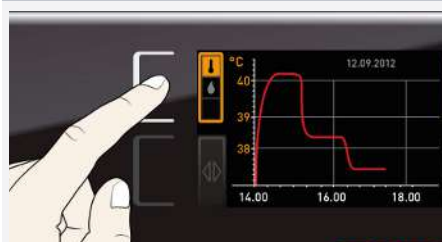

1. Activate this graphic display as described above.
2. Press the activation key next to the parameter selection.

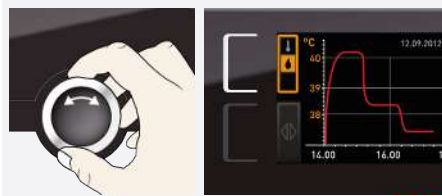

3. Set the humidity 🌧️ with the turn control.

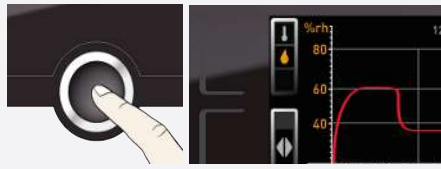

4. Press the confirmation key to confirm.
- ⇒ The humidity profile is displayed.



You can displace the display range and also zoom in/out as described in ▶ 6.7.1 Temperature Curve.

See also

- 📄 Temperature Curve [▶ 41]

6.8 Ending Operation

⚠ WARNING



Hot surfaces

Depending on the operating situation, the unit and the load may be hot. Contact with hot surfaces may have serious health consequences due to burns!

- Allow the unit to cool down.
- Wear heat-resistant protective gloves when carrying out work.
- Check the temperature of surfaces before touching them.

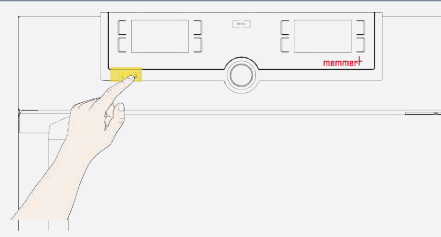

1. Switch off the active unit functions (reset setpoint values).
2. Remove the chamber load.
3. Check the water tank and top up if necessary (see ▶5.3 Water specifications).
4. Switch off the unit at the main switch.

See also

- 📄 Water specifications [▶ 26]

7. Malfunctions, Warning and Error Messages

DANGER



Risk of electric shock from unauthorised troubleshooting

Errors requiring intervention inside the unit may only be rectified by qualified electricians.

- Follow the measures listed in the event of a malfunction.
- Contact Memmert International After Sales.

Do not try to rectify appliance errors yourself; instead you should contact Memmert International After Sales or an authorised customer service point.

In case of enquiries, please always state the model and appliance number on the nameplate (see ▶3.6 Nameplate).

See also

 Nameplate [▶ 15]

7.1 Warning Message of the Monitoring Function



If the acoustic signal has been activated at Alarm in menu mode (▶8.7 Acoustic Signals, which is indicated by the speaker symbol ), the alarm will be accompanied by an intermittent acoustic signal.

The acoustic alarm can be temporarily switched off by pressing the confirmation key until the next alarm event occurs.



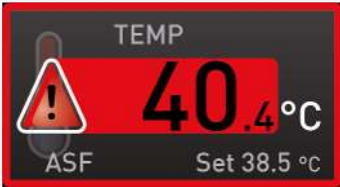
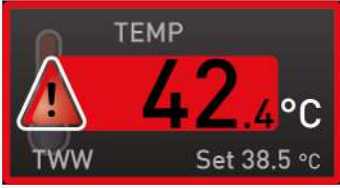

See also

 Acoustic Signals [▶ 57]



7.1.1 Temperature Monitoring



Description	Cause	Action
Temperature alarm and ASF is displayed 	Automatic temperature monitor (ASF) has triggered.	<ul style="list-style-type: none"> ■ Check that the door is closed ■ Close door ■ Increase ASF tolerance band ■ If the alarm persists: Notify customer service
Temperature alarm and TWW is displayed 	Temperature selector switch (TWW) has taken over the heating control.	<ul style="list-style-type: none"> ■ Increase the difference between the monitoring temperature and the set point temperature – i.e. either increase the max. value of the temperature monitoring or reduce the set point temperature ■ If the alarm persists: Notify customer service

7.1.2 Humidity Monitoring

Error description	Cause	Remedy
Error display symbol  	Water tank empty.	<ul style="list-style-type: none"> Fill the water tank with water and press the confirmation key
Alarm display MaxAl 	Upper humidity limit exceeded.	<ul style="list-style-type: none"> Open the door for 30 sec. and wait to see if the appliance stabilises and regulates with reference to the setpoint If the error persists, contact customer service
Alarm display MinAl 	Humidity below lower limit.	<ul style="list-style-type: none"> Check whether the door is closed Check the water supply and level of the water tank If required, replenish water If the error persists, contact customer service

7.2 Malfunctions, Operating Problems and Unit Errors

Error description	Cause of errors	Rectifying errors
Displays are dark 	External power supply was interrupted. Miniature fuse, appliance fuse or power module faulty.	<ul style="list-style-type: none"> Check the power supply Notify customer service
Displays do not activate 	Appliance locked by USER ID. Appliance is in programme, timer or remote control mode ("Write" or "Write + Alarm" mode).	<ul style="list-style-type: none"> Unlock with USER ID Wait for the programme or timer to end or switch off the remote control
Appearance of displays suddenly changes	Appliance is in the "wrong" mode.	<ul style="list-style-type: none"> Press the MENU key to switch to the operating or menu mode
Error message T:E-3 in the temperature display 	Temperature working sensor faulty. Monitoring sensor performs the measuring function.	<ul style="list-style-type: none"> The appliance can continue to be operated for a short time Notify customer service as soon as possible

Error description	Cause of errors	Rectifying errors
Error message AI E-3 in the temperature display 	Temperature monitoring sensor faulty. Working sensor performs the measuring function.	<ul style="list-style-type: none"> ■ The appliance can continue to be operated for a short time ■ Notify customer service as soon as possible
Error message E-3 in the temperature display 	Working and monitoring sensor faulty.	<ul style="list-style-type: none"> ■ Switch off appliance ■ Remove load ■ Notify customer service
Error message E-6 in the humidity display 	Humidity sensor faulty.	<ul style="list-style-type: none"> ■ Humidity control is no longer possible ■ Notify customer service
Start animation after switching on appears in a colour other than white ●●●.	Cyan ●●●: not enough storage space on the SD card.	<ul style="list-style-type: none"> ■ Notify customer service
	Red ●●●: System files could not be loaded.	
	Orange ●●●: The fonts and images could not be loaded.	

7.2.1 Power Failure

In case of a power failure, the unit operates as follows:

In manual mode

After the power supply has been restored, operation is continued with the parameters set. The time and duration of the power failure are documented in the log memory.

In timer or programme mode

In case of an interruption of the power supply of less than 60 minutes, the current programme is continued from the point at which it was interrupted. For longer interruptions of the power supply, all appliance functions are switched off.

After the power supply has been restored, the timer always starts again.

In remote control mode

The previous values are restored. If a programme has been initiated via remote control, it is continued.

8. Menu Mode

In menu mode, you can make basic settings, load programmes and export protocols, as well as adjust the appliance.



Before changing the menu settings, read the description of the respective functions on the following pages to avoid possible damage to the appliance and/or chamber load.

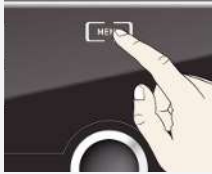

- ▶ To enter Menu mode, press the **MENU** key.
- ⇒ The appliance then returns to operating mode. Only changes applied by pressing the confirmation key are saved.
- ⇒ To exit the menu mode at any time, press the **MENU** key again.

8.1 Overview

Press the **MENU** key to toggle between displays in Menu mode:

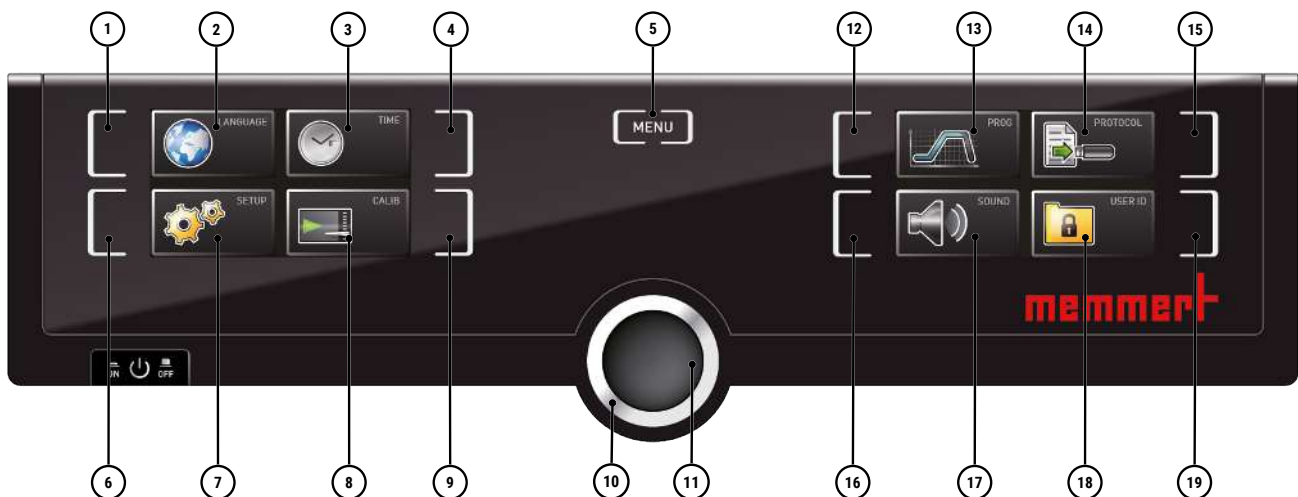

1 Language selection activation key	2 Language selection display
3 Date and time display	4 Date and time setting activation key
5 Exit menu mode and return to the operating mode	6 Setup activation key (basic appliance settings)
7 Setup display (basic appliance settings)	8 Adjustment display
9 Adjustment activation key	10 Turn control for adjustment
11 Confirmation key (applies setting made with the turn control)	12 Programme setup activation key
13 Programme setup display	14 Protocol display
15 Protocol activation key	16 Acoustic signal adjustment activation key
17 Acoustic signal adjustment display	18 User ID display
19 User ID display activation key	

8.2 Basic Operation in Menu Mode Using the Example of Language Selection

In general, all settings in Menu mode are made in the same way as operating mode: Activate the respective display, use the turn control for setting and press the confirmation key to apply the change.

A more detailed description of what you need to do is provided below, using the example of language selection. All other settings can be made accordingly. The possible settings are described below.

	<p>If no new values are entered or confirmed for approx. 30 seconds, the appliance automatically restores the former values.</p>
	<p>Activate the desired setting (in this example the language):</p> <ol style="list-style-type: none"> To do so, press the activation key to the left or right of the respective display. ⇒ The activated display is enlarged.
	<ol style="list-style-type: none"> If you want to discard the settings or exit the dialogue, press the activation key again. ⇒ The appliance returns to the menu overview. ⇒ Only the settings that you have saved by pressing the confirmation key will be applied.
	<ol style="list-style-type: none"> Select the desired new setting, e.g. Spanish (ESPAÑOL) using the turn control.
	<ol style="list-style-type: none"> Save the setting by pressing the confirmation key.
	<ol style="list-style-type: none"> To return to the menu overview, press the activation key again.
	<p>You can now</p> <ul style="list-style-type: none"> activate another menu function by pressing the corresponding activation key or return to the operating mode by pressing the MENU key.

8.3 Setup

8.3.1 Overview

In the **SETUP** display, you can set the following parameters:

- the IP address and subnet mask of the appliance's Ethernet interface (for connection to a network)
- The units of the temperature display (°C or °F, see ▶8.3.3 Unit)
- The mode of operation of the digital backwards counter with target time setting (Timer Mode, see ▶6.5.2 Digital Backwards Counter)
- The type of shelf (grid or metal panel, see ▶8.3.5 Shelf Type (Grid or metal plate))
- The heat output distribution (see ▶8.3.6 Balance)
- Remote control (see ▶8.3.8 Remote Control)

- Gateway (see ▶8.3.9 Gateway)



If the Setup menu contains more entries than can be displayed, this is indicated by the display “1/2”. This means that there is a second “page” of entries.

To display the hidden entries, use the turn control to scroll beyond the lowest entry. The page display then changes to “2/2”.

See also

- Unit [▶ 49]
- Digital Backwards Counter [▶ 34]
- Shelf Type (Grid or metal plate) [▶ 49]
- Balance [▶ 50]
- Remote Control [▶ 51]
- Gateway [▶ 51]

8.3.2 IP Address and Subnet Mask

If you want to operate one or more appliances in a network, each appliance must have its own unique IP address for identification. By default, each appliance is delivered with the IP address 192.168.100.100.

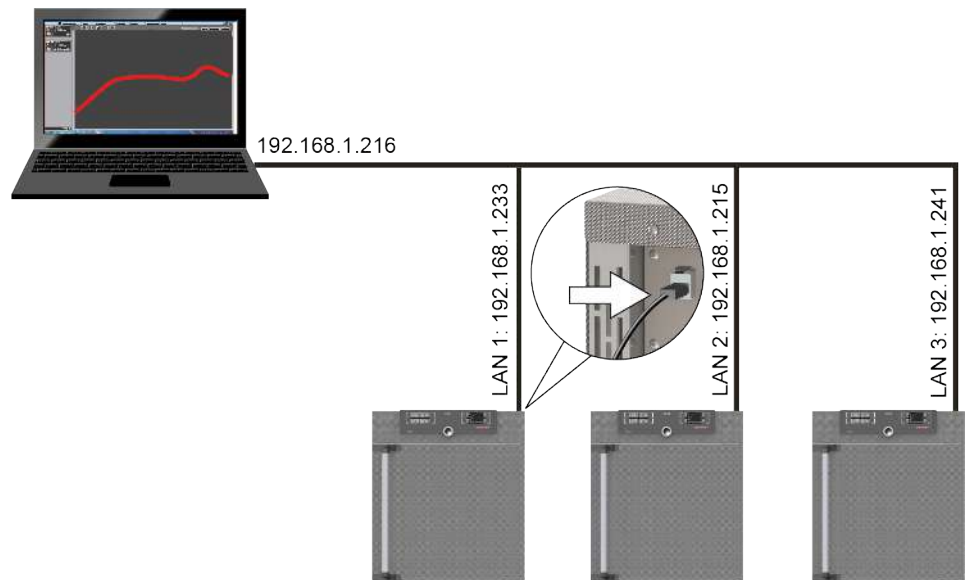

	<ol style="list-style-type: none"> 1. Activate the SETUP display. ⇒ The IP address entry is automatically highlighted.
	<ol style="list-style-type: none"> 2. Confirm the selection by pressing the confirmation key. ⇒ The first three digits of the IP address are automatically highlighted.
	<ol style="list-style-type: none"> 3. With the turn control, set the new number, e.g. 255.



4. Confirm the selection by pressing the confirmation key.
 - ⇒ The next three digits of the IP address are automatically marked.
 - ⇒ They can now also be set according to the description above.



5. After setting the last three digits, confirm the new IP address by pressing the confirmation key.
 - ⇒ The overview is displayed once again.
 - ⇒ The subnet mask can be set in the same way.

8.3.3 Unit



Here, you can choose whether the temperature is displayed in °C or °F.

8.3.4 Timer Mode

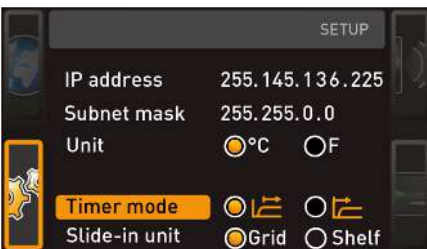

Here, you can choose whether the digital backwards counter with target time setting (see ▶6.5.2 Digital Backwards Counter) should be setpoint-dependent or not – in other words, whether the timer should not start until a tolerance band around the setpoint temperature is reached ⊕ or if it should start right after activation ⊙.

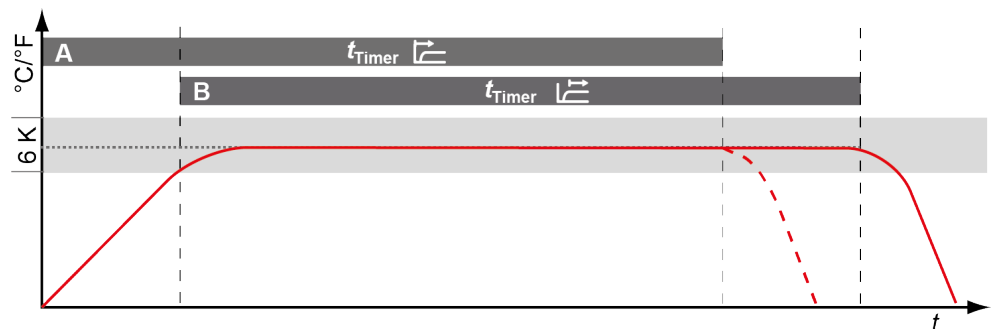

See also

📖 Digital Backwards Counter [▶ 34]

8.3.5 Shelf Type (Grid or metal plate)

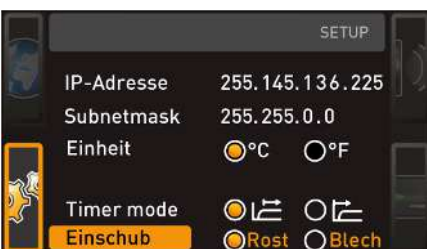

Here, you have to set the type of shelf (grid or metal panel) used. The selection **Metal panel** enables you to adjust the closed-loop control function to the different air flow characteristics in the chamber when using optional shelves instead of the grids provided as standard.

8.3.6 Balance

For appliances sizes 410 and 750, application-specific correction of the heat output distribution (balance) between the upper and lower heating groups is possible. The setting range is from -50% to +50%.

Distribution of the heating/cooling power (example):

The -20% (left) setting causes the lower heating elements to work at 20% less power than the upper ones. The +30% (right) setting causes the lower heating elements to work at 30% more power than the upper ones. The 0% setting restores the default distribution.

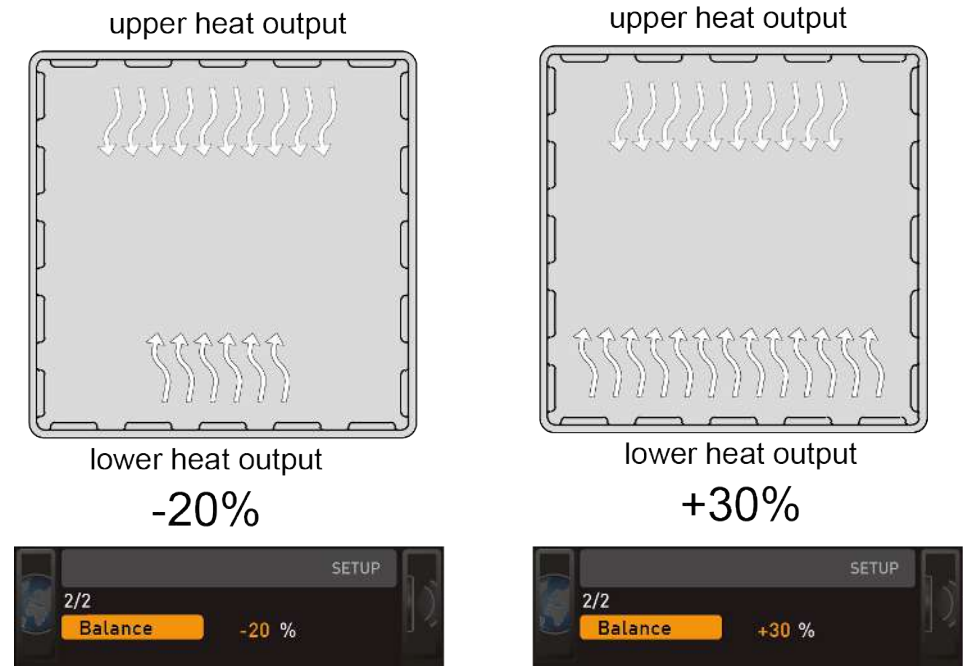

8.3.7 Dehumidification Interval



The dehumidification peltier modules behind the back panel selectively generate cold spots inside the chamber in order to remove humidity from the appliance in a controlled way.

If the appliance is dehumidifying continuously close to the lower limit of the climate diagram, the water in the air will freeze at the dehumidification peltier modules. If solid ice forms on the back panel around the dehumidification peltier modules, the dehumidification interval must be readjusted.

The dehumidification interval function allows the time spans at which the dehumidification peltier modules cool at maximum capacity to be adjusted individually. The preset value of 35 minutes is recommended for basic applications.

Setting range:

- Min. 15 minutes
- Max. 180 minutes

Example

1. Interval begins – dehumidification peltier modules cool at full power and generate the coldest point (-12 °C), depending on the set time interval.
2. Interval duration expired – dehumidification peltier modules are not operated for a short time, resulting in a local rise in temperature. The ice thaws and the melt water is removed.
3. Interval begins again.

The ideal setting for the dehumidification interval is when hardly any ice forms on the back panel and the humidity setpoint value is reached.

- The interval should be decreased if there is heavy ice formation on the back panel
- If the setpoint values are not reached, the interval should be increased
- For climate points in the low temperature range with low humidity, the interval should be extended

If you change the dehumidification interval, test whether this has a positive effect on low ice formation in the chamber.

8.3.8 Remote Control



Under the Remote control setup entry, you can set whether the appliance should be controlled via remote control and if so, in which mode. These adjustment options are available:

- Off
- Read Only
- Write + Read
- Write + Alarm



When the appliance is in remote control mode, the  symbol appears in the temperature display. In the settings **Write + Read** and **Write + Alarm**, the appliance cannot be controlled at the ControlCOCKPIT until the remote control has been switched off (**Off** setting) or set to Read Only.

To use the remote control function, programming skills and special libraries are required.

8.3.9 Gateway

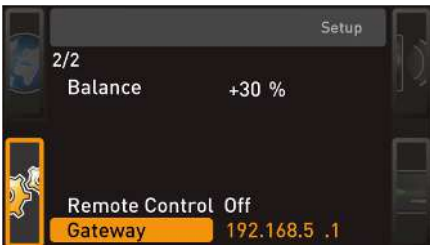

The Gateway setup entry is used to connect two networks with different protocols. The gateway is set the same way as the IP address (see ▶8.3.2 IP Address and Subnet Mask).

See also

- IP Address and Subnet Mask [▶ 48]

8.4 Date and Time

In the **TIME** display, you can set date and time, time zone and summer time. Changes can only be made in manual operating mode.















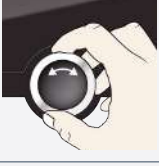

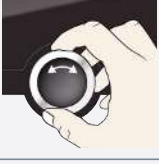
Always set the time zone (and summer time yes/no) before you set the date and time. Avoid changing the set time after that since this can lead to gaps or overlapping when recording measured values. If you still need to change the time, you should not run a programme immediately before or after doing so.

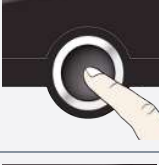

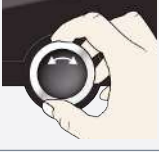
1. Press the activation key to the right of the **TIME** display.

⇒ The display is enlarged and the first adjustment option (**Date**) automatically highlighted.

 	2. Turn the turn control until Time zone is highlighted.
 	3. Confirm the selection by pressing the confirmation key.
 	4. Set the time zone of the installation site with the turn control (e.g. 00:00 for Great Britain, 01:00 for France, Spain or Germany). 5. Confirm the selection by pressing the confirmation key.
 	6. With the turn control, select the Summertime entry.
 	7. Confirm the selection by pressing the confirmation key. ⇒ The adjustment options are highlighted.
 	8. Set summertime to off (X) or on (✓) with the turn control – in this case on (✓). 9. Save the setting by pressing the confirmation key.
	The changeover between summer and winter time does not take place automatically. For this reason, please remember to adjust the setting at the start and end of the summer time.
 	10. Set the date (day, month year) and time (hours, minutes). 11. Confirm the setting by pressing the confirmation key.

8.5 Calibrate

NOTICE



To guarantee problem-free closed-loop control, we recommend calibrating the appliance once a year.

8.5.1 Temperature Calibration

The appliances are temperature calibrated and adjusted at the factory. If readjustment is necessary – for example due to the influence of the chamber load – the appliance can be calibrated for the specific customer using three possible calibration temperatures:

- Cal1 Temperature calibration at low temperature

- Cal2 Temperature calibration at medium temperature
- Cal3 Temperature calibration at high temperature



For temperature calibration, you will need a calibrated reference instrument.

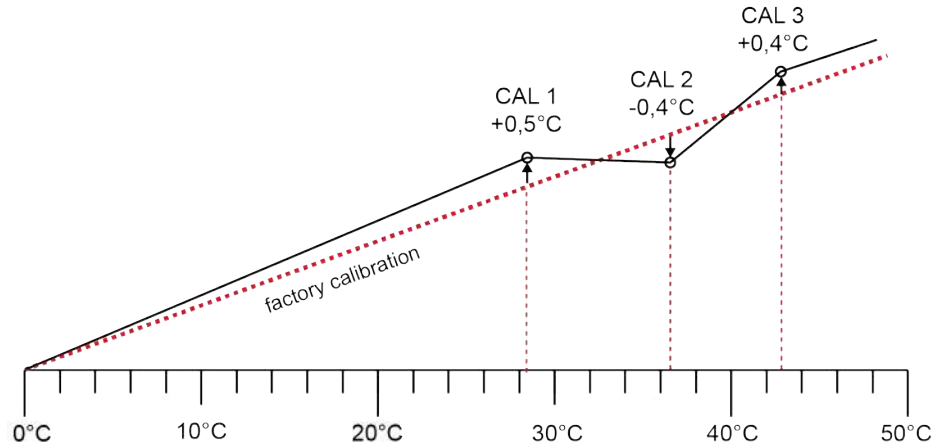

Example: Temperature deviation should be corrected



1. Press the activation key to the right of the **CALIB** display.
 ⇒ The display is enlarged and the temperature adjustment option is automatically highlighted.



2. Press the confirmation key repeatedly, until the calibration temperature Cal2 is highlighted.



3. With the turn control, set the calibration temperature Cal2 to the specified temperature.



4. Save the setting by pressing the confirmation key.
 ⇒ The corresponding calibration correction value is automatically highlighted.



5. Set the calibration correction value to 0.0 K.
6. Save the setting by pressing the confirmation key.

	<ol style="list-style-type: none"> Position the sensor of a calibrated reference instrument centrally in the working chamber of the appliance. Close the door. In manual mode, adjust the setpoint temperature.
	<ol style="list-style-type: none"> Wait until the appliance reaches and displays the setpoint temperature. <ul style="list-style-type: none"> The reference instrument will display the corresponding deviation.
	<ol style="list-style-type: none"> In the SETUP, adjust the calibration correction value Cal2 to the deviation temperature (actual value measured minus setpoint value). Save the setting by pressing the confirmation key.
	<ol style="list-style-type: none"> Compare the temperature measured by the reference measurement instrument with the temperature displayed on the appliance. <ul style="list-style-type: none"> After the calibration procedure, the temperature measured by the reference instrument should now also be the setpoint temperature.

With Cal1, a further calibration temperature below Cal2, and with Cal3 a temperature above, can be programmed in the same manner. The minimum difference between the Cal values is 10 K.

	<p>If all calibration correction values are set to 0.0 K, the factory calibration settings are restored.</p>
--	--

8.5.2 Humidity Calibration

Closed-loop humidity control can be adjusted according to customer requirements by means of three freely selectable calibration points. For each selected calibration point, a positive or negative calibration correction value between -10% and +10% can be set.

	<p>For humidity adjustment, you will need a calibrated reference instrument.</p>
--	--

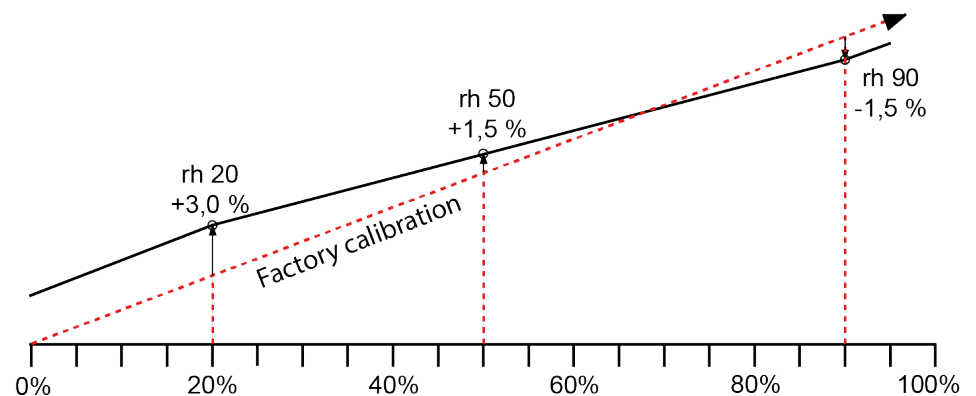

Example: Humidity deviation at 60% rh needs to be corrected



1. Press the activation key to the right of the **CALIB** display.
⇒ The display is enlarged and the temperature adjustment option is automatically highlighted.



2. Turn the turn control until **Humidity** is highlighted.



3. Press the confirmation key repeatedly, until the calibration point Cal2 is highlighted.



4. With the turn control, set the calibration point Cal2 to 60% rh.



5. Save the setting by pressing the confirmation key.
⇒ The corresponding calibration correction value is automatically highlighted.

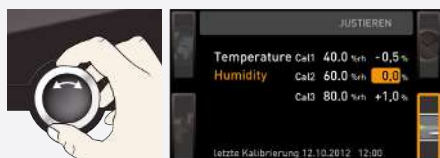

6. Set the calibration correction value to 0.0%.
7. Save the setting by pressing the confirmation key.



8. Position the sensor of the calibrated reference instrument centrally in the working chamber of the appliance.
9. Close the door.
10. In manual mode, adjust the set humidity to 60% rh.



11. Wait until the appliance reaches the set humidity and displays 60% rh.
■ Assuming the reference instrument displays 58.5% rh,



12. in the **SETUP**, adjust the calibration correction value Cal2 to -1.5% (actual value measured minus setpoint value).
13. Save the setting by pressing the confirmation key.



After the calibration procedure, the humidity measured by the reference instrument should now also be 60% rh.

8.6 Programme

In the **Programme** display, programmes created using the AtmoCONTROL software can be transferred to the appliance and saved on a USB storage medium. Here, you can also select the programme you wish to run (see ▶6.5.3 Programme Mode) and delete programmes.

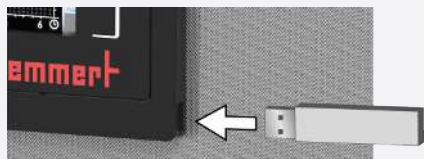

1. Insert the USB storage medium on the right side of the ControlCOCKPIT.
⇒ You can now use one of the programmes saved on the USB storage medium.



2. Press the activation key on the left of the **Prog** display.
⇒ The display is enlarged and the Select entry is automatically highlighted.
⇒ The programmes available for activation are shown on the right.
⇒ The programme currently available for use – in this example **Test 012** – is highlighted in orange.

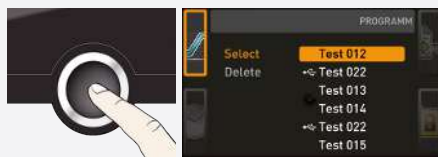

3. Press the confirmation key to access the Select function.
⇒ All available programmes are displayed, including the ones saved on the USB data storage medium (identified by the USB symbol ).
⇒ The programme currently available for use is highlighted in orange.

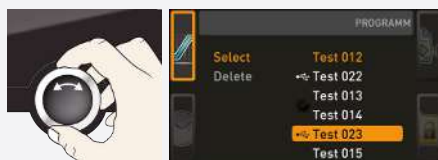

4. With the turn control, select the programme you want to use.

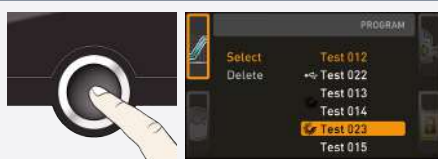

5. Confirm the selection by pressing the confirmation key.
⇒ The programme is now loaded, as indicated by the progress display.



As soon as the programme is ready, **Select** is highlighted once again.

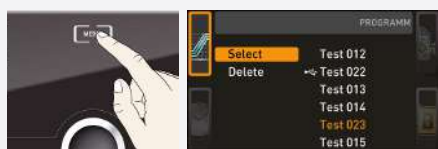

To start the programme:

6. Return to the operating mode by pressing the **MENU** key again.
7. Start the programme as described in ▶6.5.3 Programme Mode.



You can now remove the USB storage medium.

To delete a programme:

8. select the programme to be deleted the same way you can select a programme for activation.
9. Select **Delete** with the turn control.

See also

📄 Programme Mode [▶ 35]

8.7 Acoustic Signals

In the **SOUND** display, you can define whether or not the appliance should emit acoustic signals and, if yes, for which events:

- on the press of a key
- at the end of a programme
- in the event of an alarm
- if the door is open



1. Press the activation key to the left of the **SOUND** display.
 - ⇒ The display is enlarged.
 - ⇒ The first category (in this case **Keysound**) is automatically highlighted.
 - ⇒ The current settings are shown on the right.

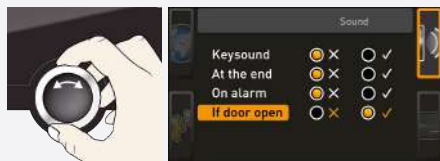

- If you want to edit another list entry:
- Turn the turn control until the respective entry – e.g. **if the door is open** (special configuration) – is highlighted in colour.

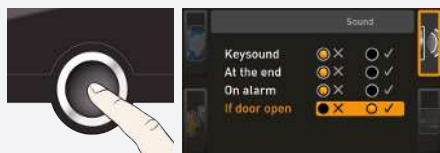

2. Confirm the selection by pressing the confirmation key.
 - ⇒ The adjustment options are automatically highlighted.

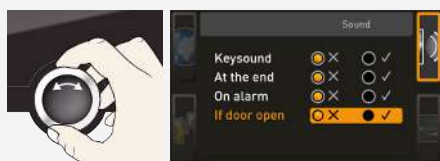

3. With the turn control, select the desired setting – in this example OFF (X).

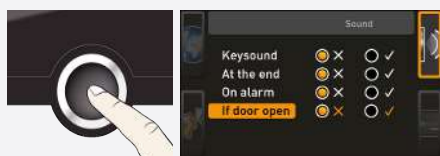

4. Save the setting by pressing the confirmation key.



If an acoustic signal sounds, it can be turned off by pressing the confirmation key.

8.8 Log

NOTICE



The supplied manual for AtmoCONTROL describes how

- to import exported log data into AtmoCONTROL,
- exported log data can be processed further in AtmoCONTROL,
- log data can be read out via Ethernet.

The appliance continually logs all relevant measured values, settings and error messages at 1-minute intervals. The internal log memory is a continuous memory type. The log function cannot be switched off and is always active. The measured data are stored in the appliance, safe from manipulation. If the power supply is interrupted, the time of the power failure and when the power was restored are stored in the appliance.



You can export the log data for different periods to a USB storage medium via the USB interface, or export the data via Ethernet and reimport it in the AtmoCONTROL software for graphic display, print-out or storage.

The log memory of the appliance is not modified or deleted by reading it out.

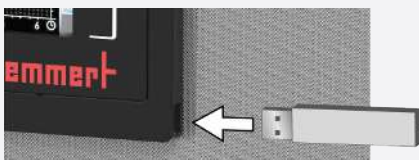

1. Connect the USB storage medium to the port on the right of the ControlCOCKPIT.

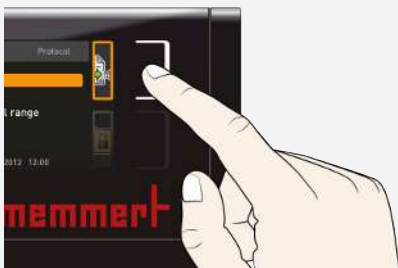

2. Press the activation key on the right side of the **Log** display.
 - ⇒ The display is enlarged and the period **This Month** automatically highlighted.
3. To select another log period, use the turn control.



4. Apply the selection by pressing the confirmation key.
 - ⇒ The transfer starts
 - ⇒ and the status bar indicates the progress.



As soon as the transfer is complete, a check mark appears in front of the period selected.

- The USB storage medium can now be removed.

8.9 USER ID

8.9.1 Description

With the USER ID function, you can lock the settings of individual (e.g. temperature) or all parameters, so that they cannot be changed at the appliance by accident or by unauthorised persons.



You can also lock adjustment options in Menu mode (e.g. adjustment of date and time settings).

- If adjustment options are locked, this is indicated by the lock symbol in the respective display.



USER ID data is entered in the AtmoCONTROL software and saved on the USB storage medium. The USB storage medium is thus acting as a key: Parameters can only be locked or unlocked if it is inserted.

A description of how to create a USER ID in AtmoCONTROL is provided in the separate AtmoCONTROL manual.

8.9.2 USER ID Activation and Deactivation

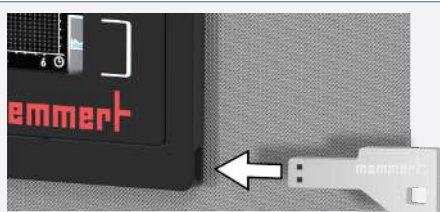

1. Insert the USB storage medium with the USER ID data into the USB port on the right of the ControlCOCKPIT.



2. Press the activation key on the right side of the **USER-ID** display.
 - ⇒ The display is enlarged and the entry **Activate** automatically highlighted.

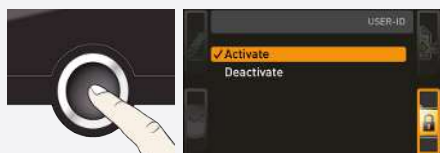

3. Confirm the activation by pressing the confirmation key.
 - ⇒ The new USER ID data are transferred from the USB storage medium and activated.
 - ⇒ As soon as activation is complete, a check mark appears in front of the corresponding entry.

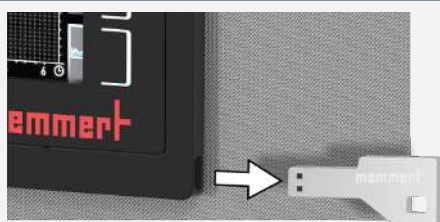

4. Remove the USB storage medium.
 - ⇒ Locked parameters are indicated by the lock symbol on the respective display.



- To unlock the appliance,
- insert the USB storage medium,
 - activate the **USER ID** display
 - and select the **Deactivate** entry.

9. Maintenance and Servicing

DANGER



Danger of suffocation inside the appliance

If the appliances is a certain size, you can get accidentally locked in, which is potentially life-threatening.

- Do not climb into the appliance.
- Do not carry out cleaning work in the chamber alone.

DANGER



Live parts

When covers are removed, live parts are exposed and contact with these parts may result in electric shock. Electric shock can have serious health consequences including death.

- Only authorised persons may carry out electrical installation work.
- Before starting work, disconnect the unit from the power supply.
- Ensure that the unit is fully de-energised.
- Secure the unit to prevent it from being switched on again.

CAUTION



Danger of cuts due to sharp edges

Touching sharp edges on the unit may result in cuts.

- Wear protective gloves during all work.
- Be careful when handling sheet metal parts.

9.1 Cleaning

Interior and metal surfaces

Regular cleaning of the easy-to-clean bath prevents build up of material residues that could impair the appearance and functionality of the stainless steel chamber over time.

The metal surfaces of the waterbath can be cleaned with normal stainless steel cleaning agents. Make sure that no rusty objects come into contact with the interior or with the stainless steel housing. Rust deposits can lead to an infection of the stainless steel. If rust spots appear on the surface of the interior due to impurities, the affected area must be immediately cleaned and polished.

Plastic parts

Do not clean plastic parts of the waterbath with caustic or solvent-based cleaning agents.

Glass surfaces

Glass surfaces can be cleaned with a commercially available glass cleaner.

Peltier cooling modules

In order to guarantee perfect function and long lifetime of the Peltier cooling modules, it is absolutely essential that you remove dust deposits from the heat sink on the back of the appliance (with a vacuum cleaner, paintbrush or bottle brush, depending on the amount).

9.2 Decontamination

⚠ CAUTION



Irritation of the skin and eyes

Skin and eye contact with decontaminants may cause irritation of the hands and eyes or allergic reactions and chemical burns.

- Wear chemical-resistant gloves during decontamination.
- For correct application, follow the instructions for use on the respective container of the decontamination agent.



Memmert units can become contaminated by loading infectious substances or by environmental influences at the place of installation. All parts of the affected unit must be decontaminated both before sending to our service department and before disposing of the unit.



For decontamination, we recommend commercially available alcohol-based decontaminants, i.e. isopropanol and/or ethanol (total alcohol concentration less than or equal to 70%).

If you have any questions about using a decontamination agent for decontaminating Memmert units, please contact our service department.

After cleaning and decontamination, ventilate the installation site and allow the unit to dry completely.

9.3 Regular Maintenance

Once a year, grease the moving parts of the doors (hinges and lock) with thin silicone grease and check that the hinge screws are not loose.

To guarantee perfect closed-loop control, we recommend calibrating the appliance once a year (see ▶8.5 Calibrate).

See also

📖 Calibrate [▶ 52]

9.4 Repairs and Service

Repairs and service work may only be carried out by specialist Memmert personnel and qualified service providers.

NOTICE



Repairs and service work are described in a separate service manual.

10. Storage, Transport and Disposal

10.1 Storage and Transport

The appliance may only be stored and transported under the following conditions:

- in a dry enclosed, dust-free room
- disconnected from the power supply

Before storage, remove water tube and empty the water tank (see ▶5.4 Connecting and Filling the Water Tank).

See also

- 📄 Connecting and Filling the Water Tank [▶ 27]

10.2 Disposal

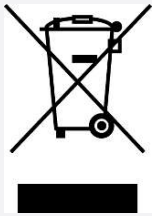

This product is subject to Directive 2012/19/EC on Waste Electrical and Electronic Equipment (WEEE) of the European Parliament and EU Council of Ministers. This unit was placed on the market after 13 August 2005 in countries which have already integrated this Directive into their national laws. It must not be disposed of as normal household waste. For disposal, please contact your dealer or the manufacturer. Any units that are infected, infectious or contaminated with materials hazardous to health are excluded from return. Please also observe all other regulations applicable in this context.

Before disposing of the appliance, please render the door locking mechanism unusable, for example to prevent playing children playing with the appliance and being locked inside.

There is a lithium battery in the ControlCOCKPIT of the appliance. Remove it and dispose of it in accordance with the regulations in your country.

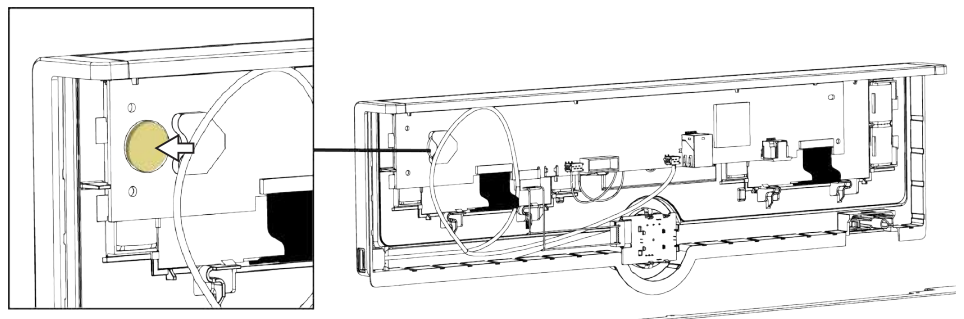

Note for Germany:

- The appliance may not be left at public or municipal collection points.

Constant Climate Chamber HPPeco

Operating manual
D53169 Effective 02/2024
English

