

Waterbath

WTB6

Ideal for the temperature control of ointments, emulsions, samples, plates and nutrient solutions in the laboratory, as well as warm storage and calibration in the industrial segment



On this page, you can find all the essential technical data on the Memmert water bath. Our customer relations team will be pleased to help if you want further information. If you should require a customised special solution, please contact our technical specialists at sales@memmert.com.

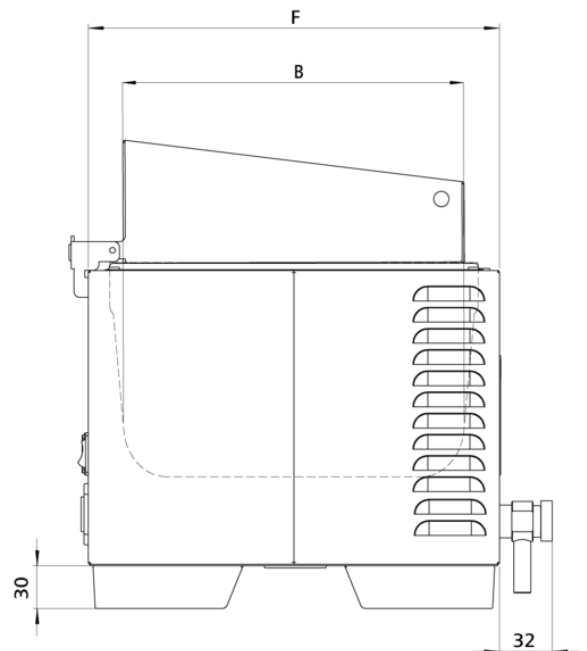
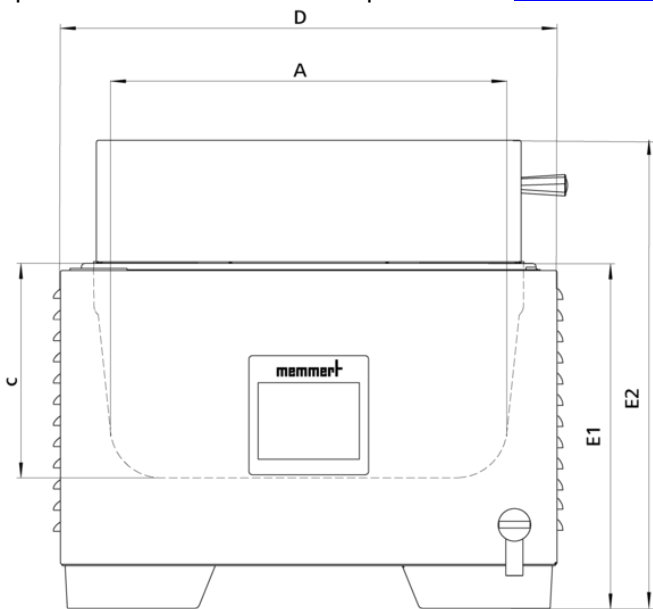

Temperature

Working temperature range at least 5 above ambient to +100 (depending on ambient pressure)

Setting temperature range +10 to +100 °C

Setting accuracy temperature 0.1 °C

Control of standard components

Controller intuitive 3.5" colour graphic display with touch screen

Safety

Temperature control Independent temperature limiter to switch off the heating in case of failure

Heating concept

Heating corrosion-proof large-area heating on the outside of the interior

Stainless steel interior

Interior Deep-drawn stainless steel tray (stainless steel W.St. 1-4301), without corners and edges for easy cleaning incl. central drain (no disturbing installations)

Dimensions W x H x D in mm $w_{(A)} \times h_{(C)} \times d_{(B)}$: 277 x 150 x 217 mm

Volume 7 l

Textured stainless steel casing

Dimensions $w_{(D)} \times h_{(E2)} \times d_{(F)}$: 349 x 328 x 289 mm

Electrical data

Voltage 230 V, 50/60 Hz

Electrical load approx. 1000 W

Voltage 230 V, 50/60 Hz

Voltage 115 V, 50/60 Hz

Electrical load approx. 1000 W

Ambient conditions

Installation The vent openings in the left and back side must remain unobstructed. Minimum wall spacing on all sides is 80 mm. The minimum spacing from the top of the bath to the next ceiling is 750 mm.

Ambient temperature +5 °C to +40 °C

Humidity rh max. 80 %, non-condensing

Overvoltage category II

Pollution degree 2

Packing/shipping data

Transport information	The appliances must be transported upright
Customs tariff number	8419 8998
Country of origin	Federal Republic of Germany
WEEE-Reg.-No.	DE 66812464
Dimensions approx incl. carton	w x h x d: 570 x 450 x 420 mm
Net weight	approx. 6 kg
Gross weight carton	approx. 10 kg

Standard units are safety-approved and bear the test marks

