

WTB15

Ideal for the temperature control of ointments, emulsions, samples, plates and nutrient solutions in the laboratory, as well as warm storage and calibration in the industrial segment

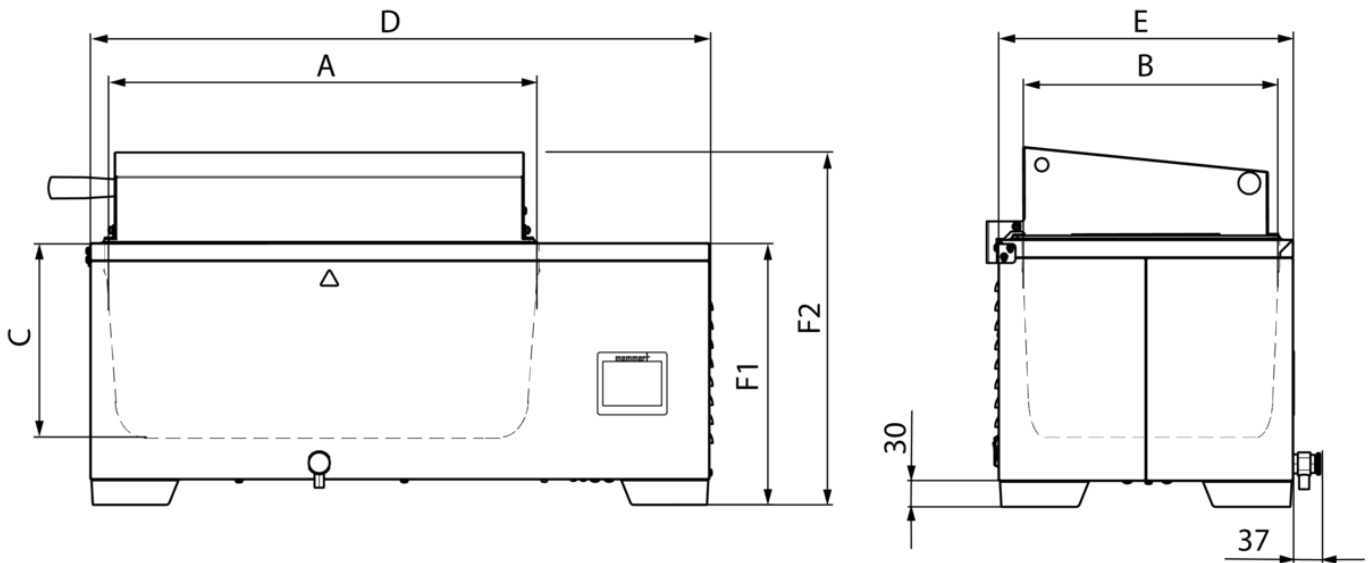

On this page, you can find all the essential technical data on the Memmert water bath. Our customer relations team will be pleased to help if you want further information. If you should require a customised special solution, please contact our technical specialists at sales@memmert.com.



Temperature

Temperature sensor	digital temperature sensor, mounted on the outside of the bath
Temperature	Setting Celsius / Fahrenheit
Working temperature range	at least 5 above ambient to +100 (with cover, depending on ambient pressure)
Setting temperature range	+10 to +100 °C
Setting accuracy temperature	0.1 °C

Control technology

Calibration	2-point calibration
Controller	intuitive 3.5" colour graphic display with touch screen
Controller	digital display of set and actual temperature and of (remaining) programme time

Safety

Temperature control	two-stage safety system to prevent overtemperature (pressure sensor for level monitoring, thermal fuse for heating shutdown in case of error)
Temperature control	individually adjustable overtemperature alarm, visual and acoustic
Temperature control	Independent temperature limiter to switch off the heating in case of failure
Autodiagnostic system	microprocessor PID-temperature controller with integrated autodiagnostic system with fault indicator

Heating concept

Heating	corrosion-proof large-area heating on the outside of the interior
----------------	---

Standard equipment

Cover	Stainless steel gable cover
Drain system	innovative drain system - easy to empty
Timer	digital timer from 1 min. up to 99 hours 59 min., visual and acoustic

Stainless steel interior

Interior	Deep-drawn stainless steel tray (stainless steel W.St. 1-4301), without corners and edges for easy cleaning incl. central drain (no disturbing installations)
Dimensions	$l_{(A)} \times w_{(B)} \times h_{(C)}$: 482 x 277 x 150 mm
Volume	17 l
Liquid level min.	20 mm
Liquid level max.	114 mm

Textured stainless steel casing

Dimensions	$l_{(D)} \times w_{(E)} \times h_{(F2)}$: 749 x 349 x 375 mm
-------------------	---

Electrical data

Voltage	230 V, 50/60 Hz
----------------	-----------------

Electrical load	approx. 1420 W
------------------------	----------------

Voltage	115 V, 50/60 Hz
----------------	-----------------

Electrical load	approx. 1420 W
------------------------	----------------

Ambient conditions

Installation	The vent openings in the left and back side must remain unobstructed. The distance to the wall must be at least 100 mm on the sides and at least 150 mm to the rear. The minimum spacing from the top of the bath to the next ceiling is 750 mm.
---------------------	--

Ambient temperature	+5 °C to +40 °C
----------------------------	-----------------

Humidity rh	max. 80 %, non-condensing
--------------------	---------------------------

Overvoltage category	II
-----------------------------	----

Pollution degree	2
-------------------------	---

Water bath	
-------------------	--

Packing/shipping data

Dimensions approx incl. carton	$l \times w \times h$: 849 x 449 x 475 mm
---------------------------------------	--

Transport information	The appliances must be transported upright
------------------------------	--

Customs tariff number	8419 8998
------------------------------	-----------

Country of origin	Federal Republic of Germany
--------------------------	-----------------------------

WEEE-Reg.-No.	DE 66812464
----------------------	-------------

Net weight	approx. 18 kg
-------------------	---------------

Gross weight carton	approx. 21 kg
----------------------------	---------------

Standard units are safety-approved and bear the test marks

